

TOSHIBA



PORTABLE DVD PLAYER SD-P1500

OWNER'S MANUAL



Introduction 2

Basic playback 20

Advanced playback 30

Function setup 44

Connections 56

Others 64



SAFETY PRECAUTIONS

CAUTION: This equipment employs a Laser System.
To ensure proper use of this product, please read this owner's manual carefully and retain for future reference. Should the unit require maintenance, contact an authorized service location - see service procedure.

Use of controls or adjustments or performance of procedures other than those specified herein may result in hazardous radiation exposure.

To prevent direct exposure to laser beam, do not try to open the enclosure.
Visible and invisible laser radiation when open and interlocks defeated.
DO NOT STARE INTO BEAM.

FCC NOTICE “Declaration of Conformity Information”

This equipment has been tested and found to comply with the limits for a Class B digital device, pursuant to part 15 of the FCC Rules. These limits are designed to provide reasonable protection against harmful interference in a residential installation.

This equipment generates, uses and can radiate radio frequency energy and, if not installed and used in accordance with the instructions, may cause harmful interference to radio communications.

However, there is no guarantee that interference will not occur in a particular installation.

If this equipment does cause harmful interference to radio or television reception, which can be determined by turning the equipment off and on, the user is encouraged to try to correct the interference by one or more of the following measures:

- Reorient or relocate the receiving antenna.
- Increase the separation between the equipment and receiver.
- Connect the equipment into an outlet on a circuit different from that to which the receiver is connected.
- Consult the dealer or an experienced radio/TV technician for help.

WARNING: Only peripherals complying with the FCC class B limits may be attached to this equipment. Operation with non-compliant peripherals or peripherals not recommended by Toshiba is likely to result in interference to radio and TV reception.
Changes or modifications made to this equipment, not expressly approved by Toshiba, or parties authorized by Toshiba, could void the user's authority to operate the equipment.

This device complies with part 15 of the FCC Rules. Operation is subject to the following two conditions:

- (1) This device may not cause harmful interference, and
- (2) this device must accept any interference received, including interference that may cause undesired operation.

In the spaces provided below, record the Model and Serial No. located on the bottom of your DVD player.

Model No. _____ Serial No. _____

Retain this information for future reference.

Location of the required label

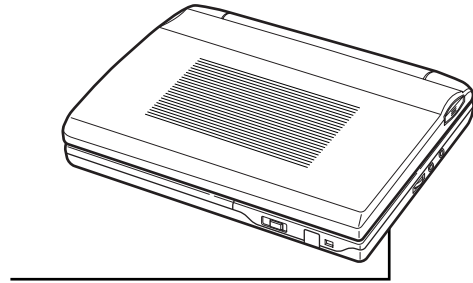
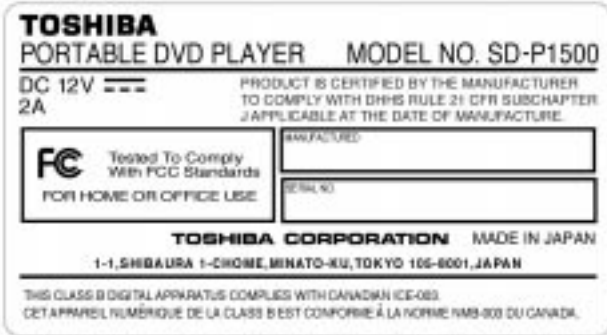

IMPORTANT SAFETY INSTRUCTIONS

CAUTION: PLEASE READ AND OBSERVE ALL WARNINGS AND INSTRUCTIONS GIVEN IN THIS OWNER'S MANUAL AND THOSE MARKED ON THE UNIT. RETAIN THIS BOOKLET FOR FUTURE REFERENCE.

This set has been designed and manufactured to assure personal safety. Improper use can result in electric shock or fire hazard. The safeguards incorporated in this unit will protect you if you observe the following procedures for installation, use and servicing. This unit is fully transistorized and does not contain any parts that can be repaired by the user.

DO NOT REMOVE THE CABINET COVER, OR YOU MAY BE EXPOSED TO DANGEROUS VOLTAGE. REFER SERVICING TO QUALIFIED SERVICE PERSONNEL ONLY.

- 1. Read owner's manual
After unpacking this product, read the owner's manual carefully, and follow all the operating and other instructions.



- 2. Power Sources
This product should be operated only from the type of power source indicated on the label. If you are not sure of the type of power supply to your home, consult your product dealer or local power company. For products intended to operate from battery power, or other sources, refer to the operating instructions.



- 3. Ventilation
Slots and openings in the cabinet are provided for ventilation and to ensure reliable operation of the product and to protect it from overheating, and these openings must not be blocked or covered. The openings should never be blocked by placing the product on a bed, sofa, rug or other similar surface. This product should not be placed in a built-in installation such as a bookcase or rack unless proper ventilation is provided or the manufacturer's instructions have been adhered to.



- 4. Heat
The product should be situated away from heat sources such as radiators, heat registers, stoves, or other products (including amplifiers) that produce heat.

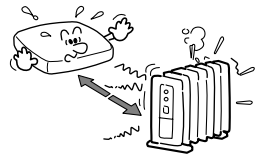

- 5. Water and Moisture
Do not use this product near water - for example, near a bath tub, wash bowl, kitchen sink, or laundry tub; in a wet basement; or near a swimming pool and the like.



- 6. Cleaning
Unplug this product from the wall outlet before cleaning. Do not use liquid cleaners or aerosol cleaners. Use a damp cloth for cleaning.



7. Power-Cord Protection

Power-supply cords should be routed so that they are not likely to be walked on or pinched by items placed upon or against them, paying particular attention to cords at plugs, convenience receptacles, and the point where they exit from the product.



8. Overloading

Do not overload wall outlets; extension cords, or integral convenience receptacles as this can result in a risk of fire or electric shock.



9. Lightning

For added protection for this product during an electrical storm, or when it is left unattended and unused for long periods of time, unplug it from the wall outlet. This will prevent damage to the product due to lightning and power-line surges.



10. Object and Liquid Entry

Never insert objects of any kind into this product through openings as they may touch dangerous voltage points or short-out parts that could result in a fire or electric shock. Never spill liquid of any kind on the product.



11. Attachments

Do not use attachments not recommended by the product manufacturer as they may cause hazards.

12. Accessories

Do not place this product on an unstable cart, stand, tripod, bracket, or table. The product may fall, causing serious injury to a child or adult, and serious damage to the product. Use only with a cart, stand, tripod, bracket, or table recommended by the manufacturer, or sold with the product. Any mounting of the product should follow the manufacturer's instructions, and should use a mounting accessory recommended by the manufacturer. A product and cart combination should be moved with care. Quick stops, excessive force, and uneven surfaces may cause the product and cart combination to overturn.



13. Lid

Be careful not to catch your fingers in the disc holder when closing the lid. It may cause personal injury.



14. Headphones

When you use headphones, keep the volume at a moderate level. If you use the headphones continuously with high volume sound, it may cause hearing damage.



15. Disc

Do not use a cracked, deformed, or repaired disc. These discs are easily broken and may cause serious personal injury and product malfunction.



16. Disc Spin

Do not touch a spinning disc. When you open the disc holder, the disc may have not stopped spinning. Touching a spinning disc may cause personal injury or damage to the product.

IMPORTANT SAFETY INSTRUCTIONS

17. Heating up

Do not use the product on your lap or other parts of body, as it may become heated. Even low temperature may cause inflaming or blistering, if touched for a prolonged period.



18. Supplied AC Adapter

Use the supplied AC adapter to operate the product. Substitute devices not specified by the manufacturer may result in fire or product malfunction.

19. Airline Passengers

When you use this product in an airplane, follow the instructions of the airline. Disregarding them may cause harmful interference to radio communication.

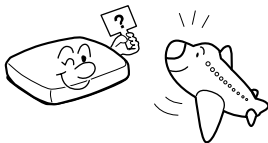

20. Pick-up Lens and Laser Beam

Do not look close the pick-up lens or stare into laser beam. Doing so may cause damage to eyesight.

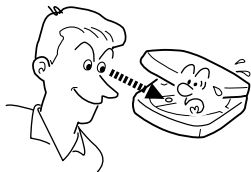

21. Traffic

Do not use this product while walking or driving. Neglecting this may cause a traffic accident.



22. LCD

Should the LCD panel be broken and liquid leaks out, do not inhale or swallow it. Doing so may cause poisoning. If you have got it into your mouth, wash it out and consult your doctor. If your hands or clothes have touched it, wipe them with alcohol and a cleaning cloth and then wash them well.

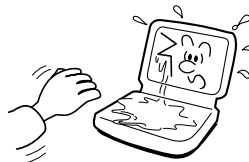

23. Battery Pack

a) Never throw the battery pack into a fire, as that could cause the battery pack to explode. Never heat the battery pack, as that could cause leakage of alkaline solution or other electrolytic substance.



b) Never disassemble the battery pack, as that could cause leakage of alkaline solution or other electrolytic substance.

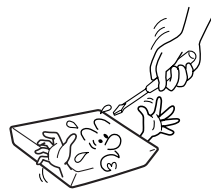

c) Never short-circuit the battery pack by either accidentally or intentionally bringing the terminals in contact with another metal object. This could cause personal injury or a fire, and could also damage the battery pack.

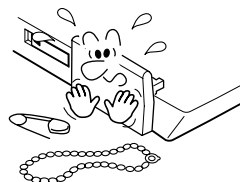

d) Never hammer a nail into the battery pack. Never strike the battery pack with a hammer. Never step or tread on the battery pack.



e) If you ever detect the emission of an extraordinary odor, excessive heat, discoloration, or deformation of the battery pack, remove it from the player or the battery charger immediately, and discontinue use of the battery pack.



f) If you ever detect rust, the emission of an extraordinary odor, excessive heat or anything unusual of the battery pack prior to use, do not use it. Take it to an authorized Toshiba service provider.

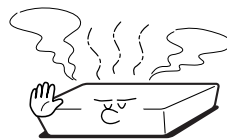

- g) Keep the battery pack away from heat or fire, if you detect the emission of an extraordinary odor or leakage of alkaline solution or other electrolytic substance.

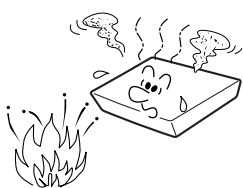

- m) Never expose the battery pack to direct sunlight. Never store or use the battery pack in a locked and unventilated vehicle. (where excessive internal temperatures may be encountered.)

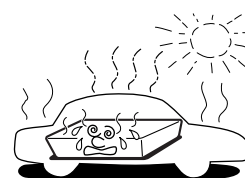

- h) Never dispose of used battery packs with other ordinary solid wastes, since they contain toxic substances. Always dispose of used battery packs in accordance with the prevailing community regulations that apply to the disposal of batteries. Cover the metal terminals with insulating tape, in order to prevent accidental short-circuiting.

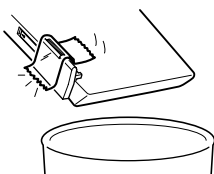

- n) Always keep the battery pack out of reach of infants or small children.



- i) Always confirm that the battery pack is compatible with your player, before attaching the battery pack to the player.

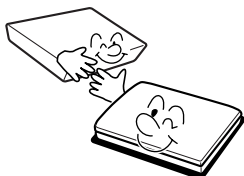

- o) Never shock the battery pack by dropping or throwing it.



- j) Never expose the terminals of the battery pack to any other metal object. Wrap the battery or place it in a protective plastic bag, whenever transporting it.

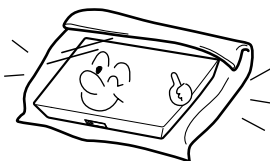

- p) If the liquid contained within the battery pack leaks, use a large amount of water and immediately wash off any liquid which may accidentally contact any part of the body. Remove any liquid that has contacted your clothes by washing them immediately with a detergent.

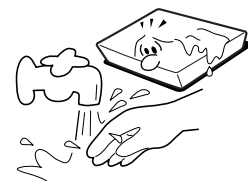

- k) Always confirm that the temperature is 5-35°C before you charge the battery. Leakage, excessive heat, or deterioration of the battery pack may occur if this warning is not heeded.

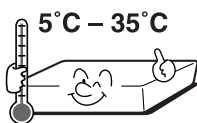

- q) Always confirm that a "click" sound has resulted, when attaching the battery pack to the player. This sound confirms that the battery pack has been properly attached.



- l) Never expose the battery pack to any liquid.



IMPORTANT SAFETY INSTRUCTIONS

24. Coin-shaped Battery

- a) Keep coin-shaped batteries out of children's reach. Be careful not to ingest internally, especially by children, as doing so may cause poisoning.
- b) Do not load a battery into the remote control with the wrong side out.
- c) Do not charge, heat, open, or short-circuit the batteries. Do not throw the batteries into a fire.
- d) Do not leave a dead or exhausted battery in the remote control.
- e) If you do not use the remote control for a long period of time, remove the battery to avoid possible damage from battery corrosion.



25. Keeping of Coin-shaped Batteries

After unpacking coin-shaped batteries, store them in poly bags, etc. separately one by one when unused. If you leave them unwrapped, they may be short-circuited by contact with metal objects, resulting in battery leakage, heat or bursting. These may cause burns or injury. The batteries must be completely discharged when they are deposited in collection containers for old batteries in shops and at public collection sites. If a charge remains, countermeasures to prevent short circuits must be taken.



26. Damage Requiring Service

Unplug this product from the wall outlet and refer to qualified service personnel under the following conditions:

- a) When the power-supply cord or plug is damaged.
- b) If liquid has been spilled, or objects have fallen into the product.
- c) If the product has been exposed to rain or water.
- d) If the product does not operate normally by following the operating instructions. Adjust only those controls that are covered by the operating instructions as an improper adjustment of other controls may result in damage and will often require extensive work by a qualified technician to restore the product to its normal operation.
- e) If the product has been dropped or damaged in any way.
- f) When the product exhibits a distinct change in performance - this indicates a need for service.

27. Servicing

Do not attempt to service this product yourself as opening or removing covers may expose you to dangerous voltage or other hazards. Refer all servicing to qualified service personnel.



28. Replacement Parts

When replacement parts are required, be sure the service technician has used replacement parts specified by the manufacturer or have the same characteristics as the original part. Unauthorized substitution may result in fire, electric shock, or other hazards.

29. Safety Check

Upon completion of any service or repairs to this product, ask the service technician to perform safety checks to determine that the product is in proper operating condition.



Notes on handling

- Do not shock the LCD panel. It may cause unit damage and malfunction.
- When shipping the player, the original shipping carton and packing materials come in handy. For maximum protection, repack the unit as it was originally packaged at the factory.
- Do not use volatile liquids, such as insect spray, near the player. Do not leave rubber or plastic products in contact with the player for a long time. They will leave marks on the finish.
- The top and rear panels of the player may become warm after a long period of use. This is not a malfunction.
- When the player is not in use, be sure to remove the disc and turn off the power.
- If you do not use the player for a long period, the unit may not function properly in the future. Turn on and use the player occasionally.

Notes on locating

- When you place this player near a TV, radio, or VCR, the playback picture may become poor and the sound may be distorted. In this case, move the player away from the TV, radio, or VCR.

Notes on cleaning

- Use a soft, dry cloth for cleaning. For stubborn dirt, soak the cloth in a weak detergent solution, wring well and wipe. Use a dry cloth to wipe it dry. Do not use any type of solvent, such as thinner and benzene, as they may damage the surface of the player. If you use a chemical saturated cloth to clean the unit, follow that product's instructions.
- When cleaning the LCD panel, use a soft, dry cloth.

To obtain a clear picture

The player is a high technology, precision device. If the optical pick-up lens and disc drive parts are dirty or worn down, the picture quality becomes poor. To obtain a clear picture, we recommend regular inspection and maintenance (cleaning or parts replacement) every 1,000 hours of use depending on the operating environment. For details, contact your nearest dealer.

Notes on moisture condensation

Moisture condensation damages the player. Please read the following carefully.

Moisture condensation occurs, for example, when you pour a cold drink into a glass on a warm day. Drops of water form on the outside of the glass. In the same way, moisture may condense on the optical pick-up lens inside this unit, one of the most crucial internal parts of the player.

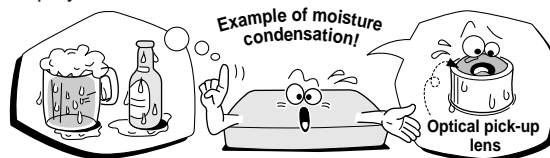

■ **Moisture condensation occurs during the following cases.**

- When you bring the player directly from a cold place to a warm place.
- When you use the player in a room where you just turned on the heater, or a place where the cold wind from the air conditioner directly hits the unit.
- In summer, when you use the player in a hot and humid place just after you move the unit from an air conditioned room.
- When you use the player in a humid place.

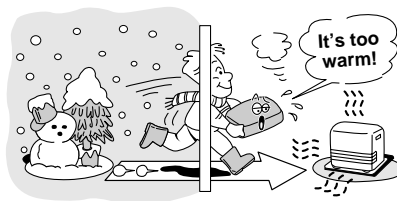

■ **Do not use the player when moisture condensation may occur.**

If you use the player in such a situation, it may damage discs and internal parts. Remove the disc, connect the power cord of the player to the wall outlet, turn on the player, and leave it for two or three hours. After two or three hours, the player will have warmed up and evaporated any moisture. Keep the player connected to the wall outlet and moisture condensation will seldom occur.



Notes and Information

On handling discs

- Do not touch the playback side of the disc.

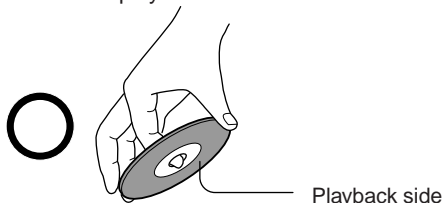

- Do not attach paper or tape to discs.



On cleaning discs

- Fingerprints and dust on the disc cause picture and sound deterioration. Wipe the disc from the center outwards with a soft cloth. Always keep the disc clean.

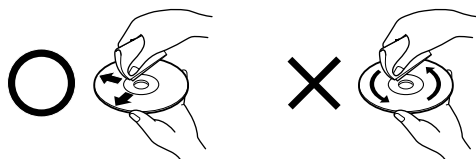

- If you cannot wipe off the dust with a soft cloth, wipe the disc lightly with a slightly moistened soft cloth and finish with a dry cloth.
- Do not use any type of solvent such as thinner, benzene, commercially available cleaners or antistatic spray for vinyl LPs. It may damage the disc.

On storing discs

- Do not store discs in a place subject to direct sunlight or near heat sources.
- Do not store discs in places subject to moisture and dust such as a bathroom or near a humidifier.
- Store discs vertically in a case. Stacking or placing objects on discs outside of their case may cause warping.

Structure of disc contents

Normally, DVD video discs are divided into titles, and the titles are sub-divided into chapters. VIDEO CDs and audio CDs are divided into tracks.

DVD video disc

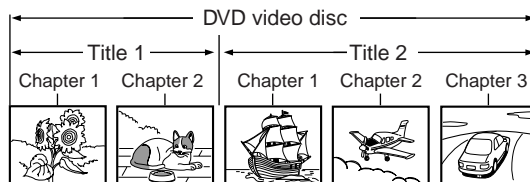

VIDEO CD/audio CD



Each title, chapter or track is assigned a number, which is called "title number", "chapter number" or "track number" respectively.

There may be discs that do not have these numbers.

Notes on copyright

It is forbidden by law to copy, broadcast, show, broadcast on cable, play in public, and rent copyrighted material without permission.

DVD video discs are copy protected, and any recordings made from these discs will be distorted.



This product incorporates copyright protection technology that is protected by method claims of certain U.S. patents and other intellectual property rights owned by Macrovision Corporation and other rights owners. Use of this copyright protection technology must be authorized by Macrovision Corporation, and is intended for home and other limited viewing uses only unless otherwise authorized by Macrovision Corporation. Reverse engineering or disassembly is prohibited.

About this owner's manual

This owner's manual explains the basic instructions of this player. Some DVD video discs are produced in a manner that allows specific or limited operation during playback. As such, the player may not respond to all operating commands. This is not a defect in the player. Refer to instruction notes of discs.

"Ⓞ" may appear on the screen during operation. A "Ⓞ" means that the operation is not permitted by the player or the disc.

Notes on region numbers

The region number of this player is 1. If region numbers, which stand for their playable area, are printed on your DVD video disc and you do not find  or , disc playback will not be allowed by the player. (In this case, the player will display a message on-screen.)

On VIDEO CDs

This player supports VIDEO CDs equipped with the PBC (Version 2.0) function. (PBC is the abbreviation of Playback Control.)

You can enjoy two playback variations depending on types of discs.

- VIDEO CD not equipped with PBC function (Version 1.1)
Sound and movie can be played on this player in the same way as an audio CD.
- VIDEO CD equipped with PBC function (Version 2.0)
In addition to operation of a VIDEO CD not equipped with the PBC function, you can enjoy playback of interactive software with search function by using the menu displayed on the screen (Menu Playback). Some functions described in this owner's manual may not work with all discs.

Playable discs

This player can play the following discs.

	Disc Mark	Contents	Disc Size	Maximum playback time
DVD video discs		Audio + video (moving pictures)	12 cm	Approx. 4 hours (single sided disc)
				Approx. 8 hours (double sided disc)
			8 cm	Approx. 80 minutes (single sided disc)
				Approx. 160 minutes (double sided disc)
VIDEO CDs		Audio + video (moving pictures)	12 cm	Approx. 74 minutes
			8 cm	Approx. 20 minutes
Audio CDs		Audio	12 cm	Approx. 74 minutes
			8 cm (CD single)	Approx. 20 minutes
<p>The following discs are also available.</p> <ul style="list-style-type: none"> ● CD-R ● CD-RW <p>CD-R/RW discs recorded by CD-DA method can be played. Some CD-R/RW discs may be incompatible.</p>				

- You cannot play discs other than those listed above.
- You cannot play discs of DVD-RAM, DVD-RW, etc. or non-standardized discs, even if they may be labeled as above.
- This player uses the NTSC color system, and cannot play DVD video discs recorded in any other color system (PAL, SECAM, etc.).

Notes and Information (continued)

Exemptions

- Toshiba Corporation is not liable for any damage caused by fire, earthquake, uses by a third person, accidents, owner's intentional or unintentional misuse, or uses in other improper conditions.
- Toshiba Corporation is not liable for incidental damages (such as profit loss or interruption in business, etc.) caused by use or misuse of this player.
- Toshiba Corporation is not liable for any damage caused by neglect of the instructions described in the owner's manual.
- Toshiba Corporation is not liable for any damage caused by misuse or malfunction through joint use of this player and the connected equipment or software that Toshiba Corporation is not concerned.

On disposal

This product contains mercury. Disposal of this material may be regulated due to environmental considerations. For disposal or recycling information, please contact your local government or the Electronic Industries Alliance.

Table of Contents

Introduction

- SAFETY PRECAUTIONS 2
- IMPORTANT SAFETY INSTRUCTIONS ... 4
- Precautions 9
- Notes and Information 10
 - Notes on region numbers 11
- Table of Contents 13
- Identification of Controls 14
 - Main unit 14
 - Side view 15
 - Rear side 15
 - Remote control 16
 - Loading a battery 17
 - Operating with the remote control 17
- Power Connection 18

Basic playback

- Playing a Disc 20
 - Basic playback 20
- Variable Speed Playback 24
 - Playing in fast reverse or fast forward directions 24
 - Playing frame by frame 24
 - Playing in slow-motion 25
 - Resuming playback from the same location ... 25
- Locating a Specific Title, Chapter, or Track 26
 - Locating a title using the top menu 26
 - Locating a title by entering the title number 26
 - Locating a specific chapter or track directly 27
 - Locating a specific chapter or track 27

Advanced playback

- Accessing a Specific Location Directly .. 30
 - Entering the time counter of the desired location ... 30
- Playing Repeatedly 31
 - Repeating a title, chapter, or track 31
 - Repeating a specific segment 31
- Playing in a Favorite Order 32
 - Setting titles, chapters, or tracks in a favorite order 32
- Playing in Random Order 33
 - Playing titles, chapters or tracks in random order 33
- Zooming a Picture 34
 - Zooming a picture 34

- Selecting the Picture Enhancement (E.P.M.) 35
 - Selecting the picture enhancement 35
- Selecting the Sound Enhancement (E.A.M.) 36
 - Selecting the sound enhancement 36
- Selecting a Camera Angle 37
 - Changing the camera angle 37
- Selecting Subtitles 38
 - Selecting a subtitle language 38
- Selecting a Language 39
 - Selecting a playback audio setting 39
- Operating in the On-screen Display Mode 40
 - On-screen display operation 40

Function setup

- Customizing the Function Settings 44
 - Setting procedure 44
 - Setting details 46
- Table of Languages 53
 - Table of languages and their abbreviations 53

Connections

- Connecting to a TV 56
- Connect to Headphones 57
- Viewing Pictures from Connected Video Equipment 57
- Connecting to Optional Equipment 58
 - Connecting to an amplifier equipped with a Dolby Digital decoder 58
 - Connecting to an amplifier equipped with Dolby Pro Logic Surround 58
 - Connecting to an amplifier equipped with a DTS decoder 58
 - Connecting to an amplifier equipped with an MPEG2 audio decoder 59
 - Connecting to an amplifier equipped with a digital audio input 59
- Using the battery pack 60

Others

- Before Calling Service Personnel 64
- Specifications 65
- LIMITED WARRANTY PORTABLE DVD PLAYER 66

Identification of Controls

See the page in for details.

Main unit

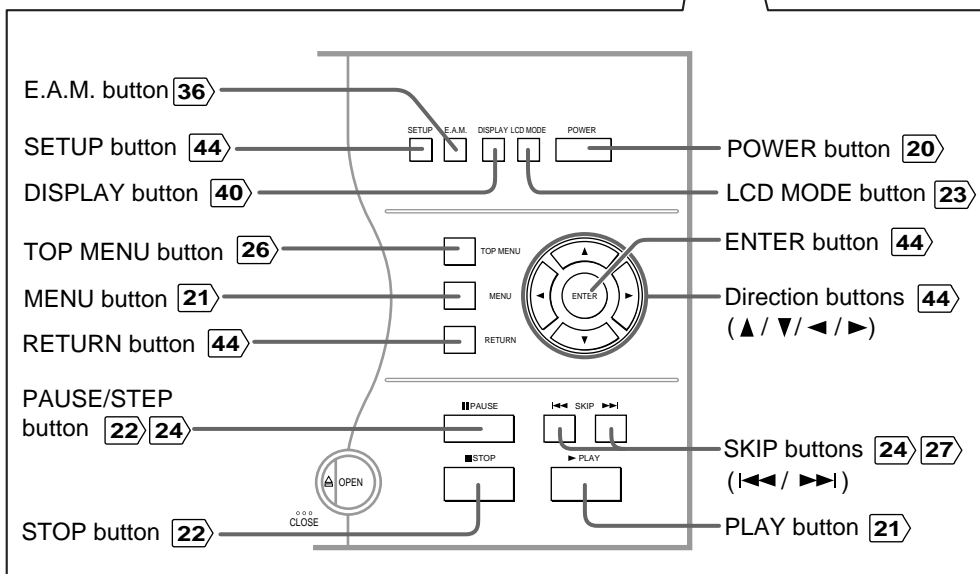
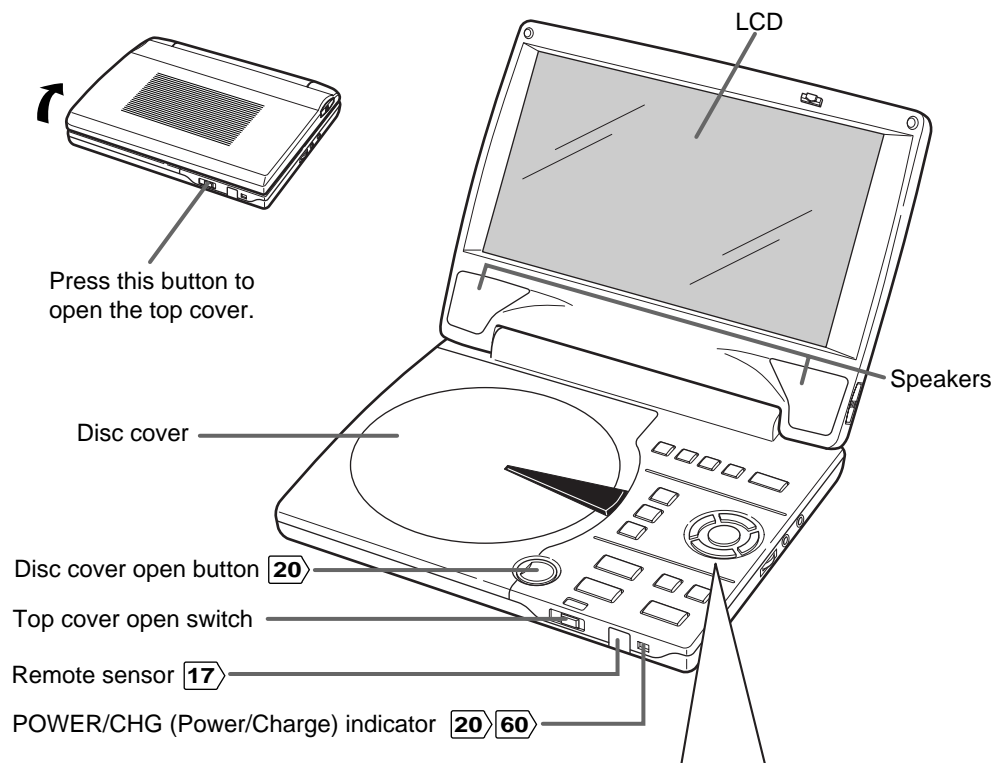

Identification of Controls (continued)

See the page in  for details.

Side view

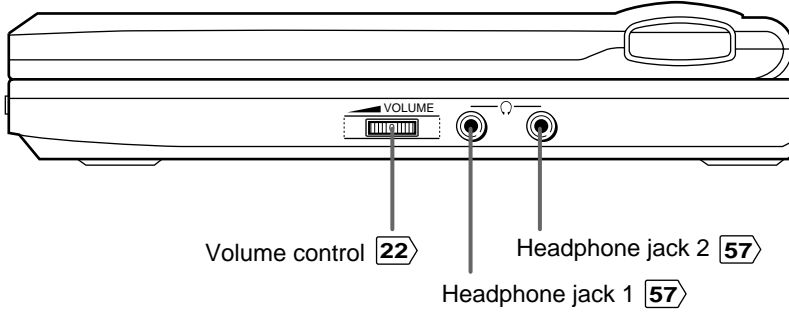

Rear Side

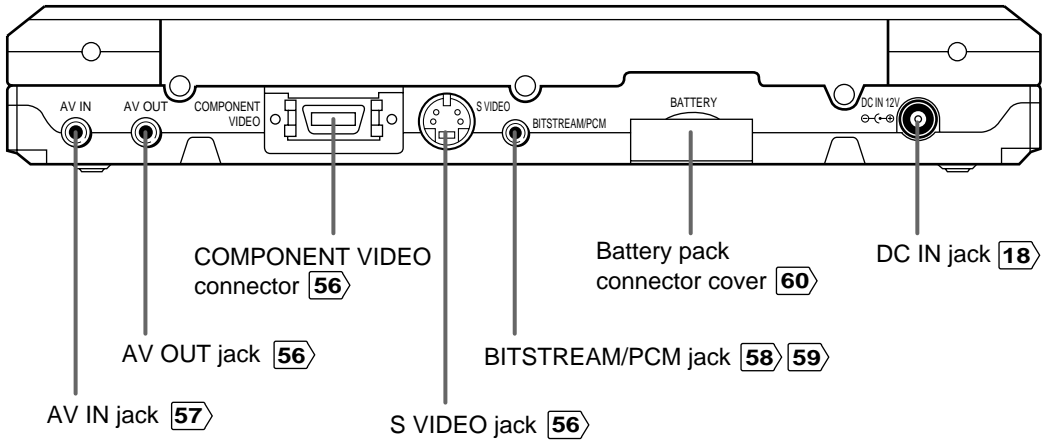

Identification of Controls (continued)

The instructions in this manual describe the functions of remote control. See the page in for details.

Remote control

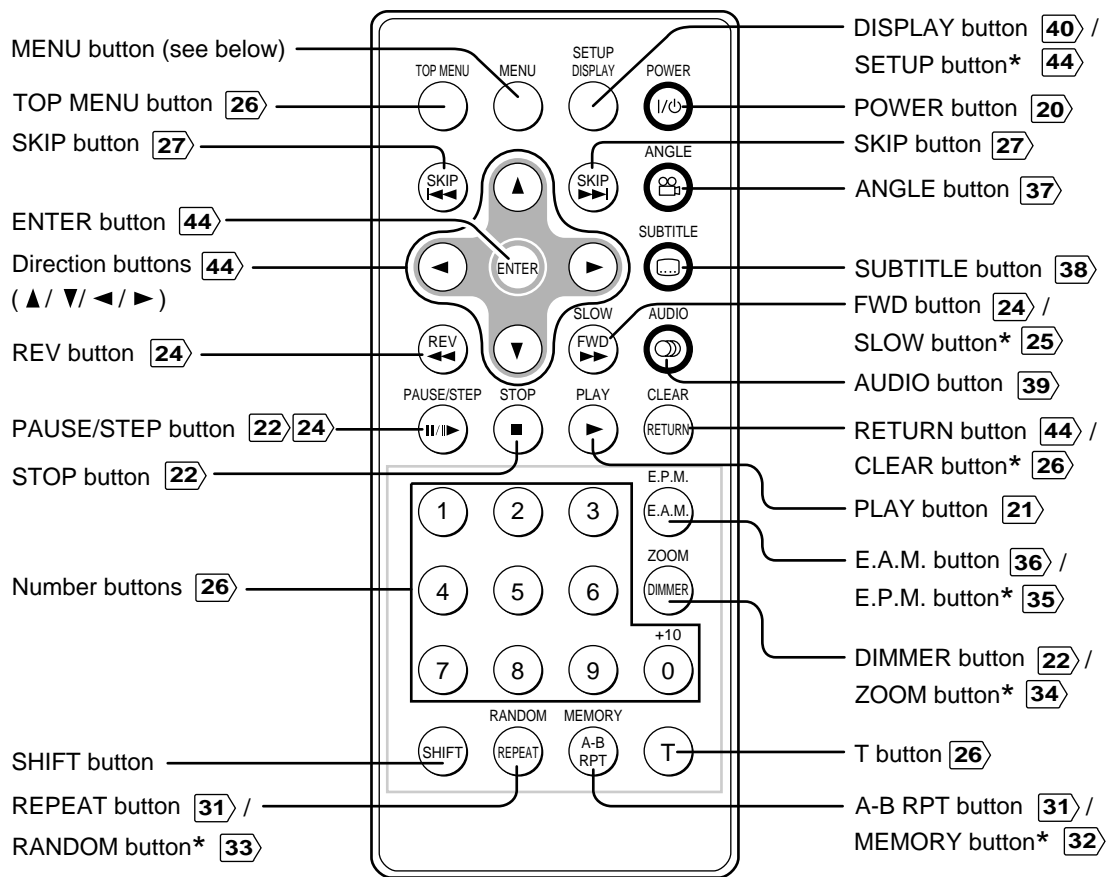

" * " buttons
Operate these buttons while simultaneously pressing the SHIFT button.

MENU button
Use the MENU button to display the menu included on many DVD video discs. To operate a menu, follow the instructions in "Locating a title using the top menu." **26**

Loading a battery

- 1** While pushing the holder in direction ①, simultaneously slide it out in direction ②.

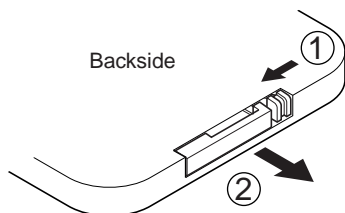

- 2** Set a coin-shaped battery (CR2025) with the \oplus side up on the holder.

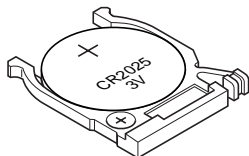

Keep the holder horizontal so that the battery does not fall through.

- 3** Push the holder back into its receptacle.

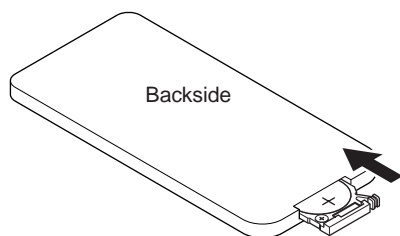

Notes on coin-shaped batteries

- If the remote control does not function correctly or if the operating range becomes reduced, replace the battery with new one.
- See **8** for safety use of coin-shaped batteries.

Operating with the remote control

- Point the remote control at the remote sensor and press the buttons.

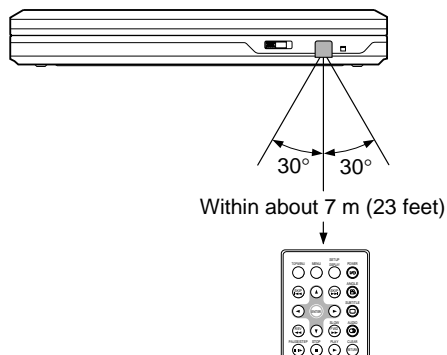

Distance: About 7 m (23 feet) from the front of the remote sensor

Angle: About 30° in each direction of the front of the remote sensor

- * Do not expose the remote sensor of the player to a strong light source such as direct sunlight or other illumination. If you do so, you may not be able to operate the player via the remote control.

Notes on the remote control

- Direct the remote control at the remote sensor of the player.
- Do not drop or give the remote control a shock.
- Do not leave the remote control near an extremely hot or humid place.
- Do not spill water or put anything wet on the remote control.
- Do not open the remote control.

Power Connection

Connect the supplied AC adapter to power the player.
For outdoor use, the battery pack (supplied) is also available.
When using the battery pack, follow the instructions on page 60.

Caution

- Do not connect the power plug to a power outlet other than that indicated on the label, as this can result in a risk of fire or electric shock.
- Do not connect or disconnect the power plug with wet hands. Doing so may cause electric shock.
- Do not use an AC adapter other than one specified, as it can cause a fire or damage to the player.

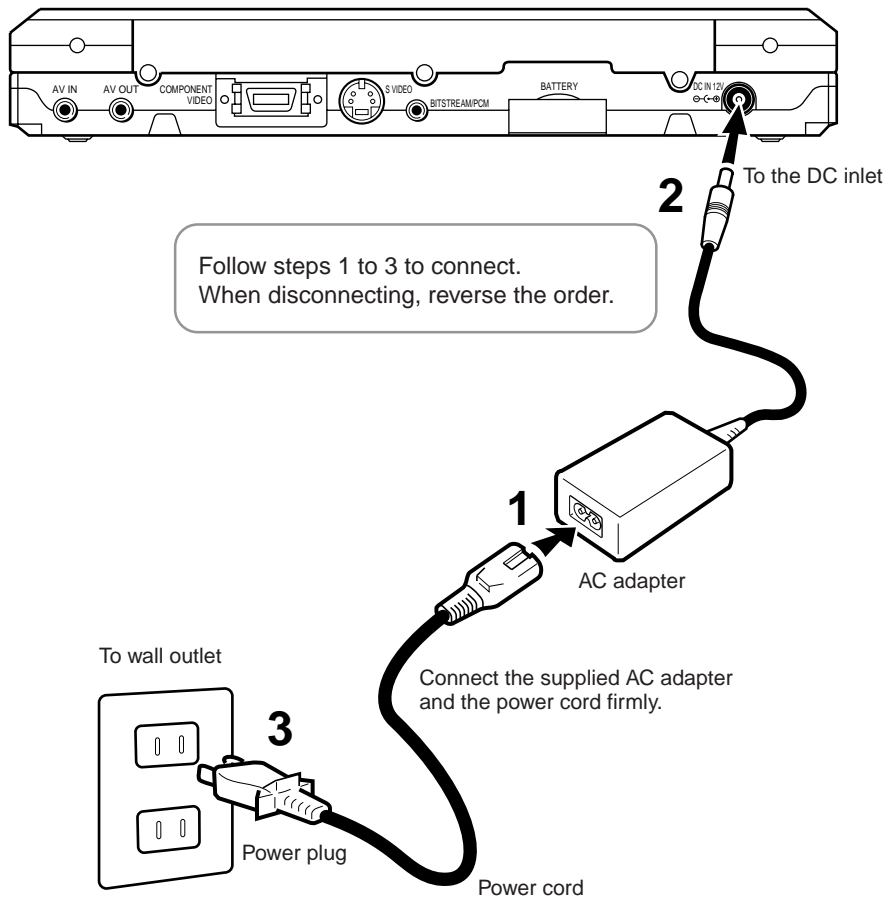



Basic playback

Begin your operation.



- **Playing a Disc**
- **Variable Speed Playback**
- **Locating a Specific Title, Chapter, or Track**

About this manual

- The numbers indicated with lines on the illustrations correspond to the numbers of the steps in the operations.
- Aside from the section "Playing a Disc" (pages 20 to 23), explanations of operations only include illustrations of the buttons on the remote control, but the buttons with the same names on the main unit can be used in the same way.

Playing a Disc

This section shows you the basics on how to play a disc.

 indicates a reference page of this manual.
See the page in  for details.





CAUTION

- Keep your fingers well clear of the disc as it is spinning. Neglecting to may cause serious personal injury.
- Be careful not to catch your fingers in the disc holder.
- Do not use a cracked, deformed, or repaired disc.



Basic playback

Preparations

- Connect the AC adapter  or the battery pack  to the player.
- When you want to view a disc on a connected TV or monitor, turn on the equipment and select the video input connected to the player.
- When you want to enjoy the sound of discs from an audio system, turn the audio system on and select the input connected to the player.
- If you use the supplied remote control, make sure that batteries are loaded in it. 
- If you use the headphones, see “Connect to headphones”. 
- Slide the top cover open button rightwards to open the top cover.

Slide this switch rightwards to open the top cover.

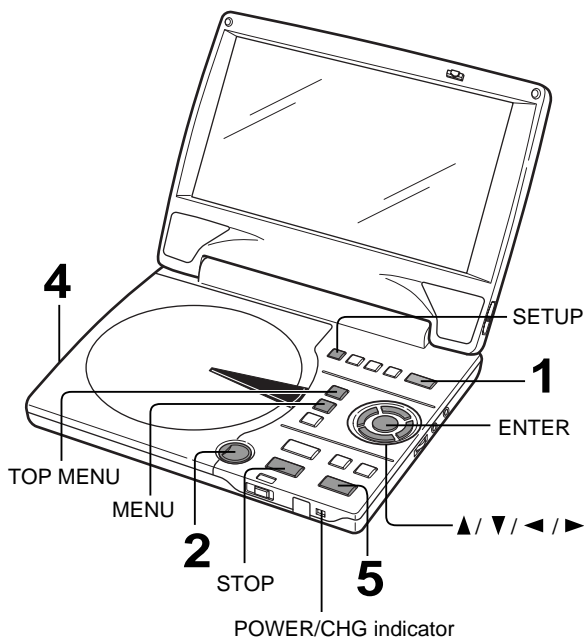
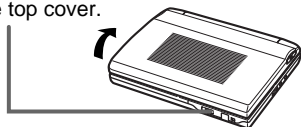

1 Turn on the power.

POWER Press POWER.

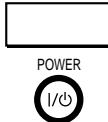

The player turns on and the POWER/CHG indicator on the player illuminates in green.

When the player is turned on for the first time, an initial set-up display appears. See “Initial Setup” and make the proper settings before proceeding to step 2.

2 Open the disc cover.

Press OPEN on the main unit. The disc cover opens.



The cover is designed to stop at 2 positions. Do not force the cover open further, as it may cause damage to the player.

3 Set a disc.

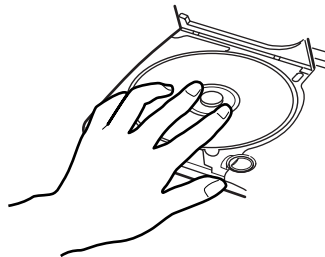

Place a disc with the playback side down, and push gently on the center of the disc to affix it to the spindle.

4 Close the disc cover.

Press CLOSE on the right corner.

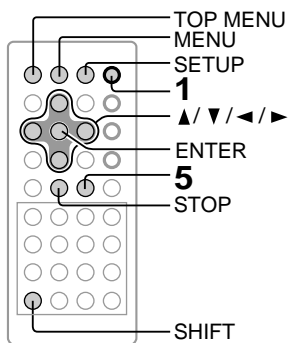

■ **To obtain a higher quality picture**

Occasionally, some picture noise not usually visible during a normal broadcast may appear on the TV screen while playing a DVD video disc because the high resolution pictures on these discs include a lot of information. While the amount of noise depends on the TV you use with this player, you should generally reduce the sharpness adjustment on your TV when viewing DVD video discs.

■ **About**

The icons on the heading bar show the playable discs relevant to the function described under each heading.

: You can use this function with DVD video discs.

: You can use this function with VIDEO CDs.

: You can use this function with audio CDs.

5 Start playback.

▶ **PLAY** Press **PLAY**.



If you select a DVD video disc that contains a top menu, or select a PBC (Playback Control)-featured VIDEO CD (), a menu may appear.

- See "Locating a title using the top menu".
- You may need to press the **TOP MENU** or **MENU** button to display disc menu (depending on the actual DVD video disc.)

■ **Initial set-up**

Make the following settings on the display.

On-Screen Language: Select the appropriate on-screen language.

TV Shape: Select a picture size according to the aspect ratio of your TV. When you use the LCD of this player, select "16:9 Widescreen." (See for details.)

Audio Out Select: Select the output sound format corresponding to your audio system connection. (See for details.)

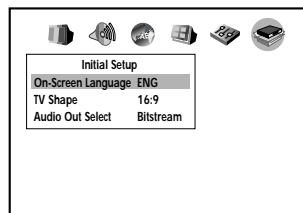

■ **To start playback in the stop mode.**

Press **PLAY**.



Notes

- Do not put an unplayable disc or any objects other than discs in the disc holder.
- Do not tilt, shake or move the main unit while playing. It may damage the disc.
- In many instances, a menu screen will appear after playback of a movie is completed. Prolonged display of an on-screen menu may damage your television set, permanently etching that image onto its screen. To avoid this, be sure to press the **STOP** button once the movie is completed.

- 1 Press **▲** / **▼** to select "On-Screen Language," and press **ENTER**.
- 2 Select a language using **▲** / **▼**, and press **ENTER**.
- 3 Press **▼** to select "TV Shape," and press **ENTER**.
- 4 Select a picture size using **▲** / **▼**, and press **ENTER**.
- 5 Press **▼** to select "Audio Out Select," and press **ENTER**.
- 6 Select an output sound using **▲** / **▼**, and press **ENTER**.
- 7 Finally press **SETUP**. (If you use the remote control, press **SETUP** while pressing **SHIFT**.)

All your selections are entered and the display disappears.

To change your settings, see "Customizing the Function Settings."

Playing a Disc (continued)

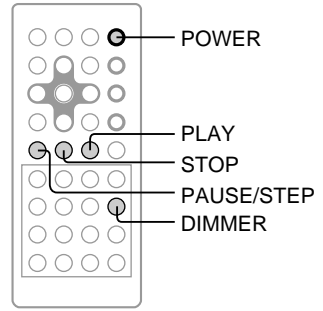

Basic playback (continued)

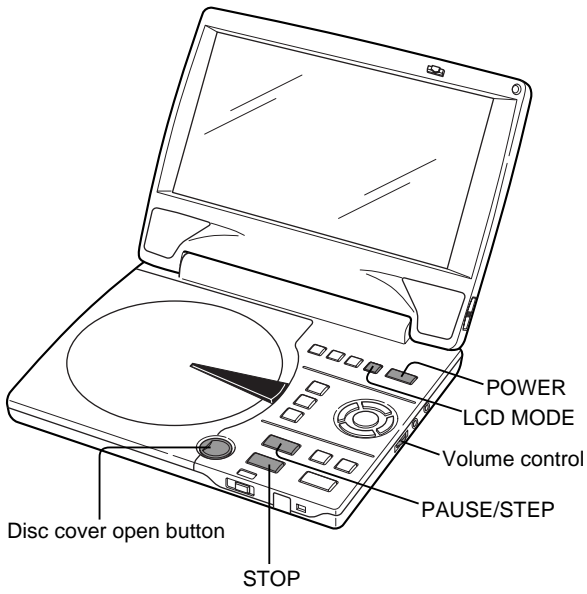

To pause playback (still mode)

Press **PAUSE/STEP** during playback.

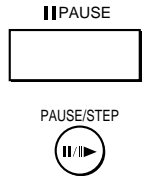

To resume normal playback, press **PLAY**.

- Sound is muted during still mode.

To stop playback

Press **STOP**.

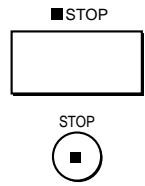

To turn off the power

Press **POWER**.

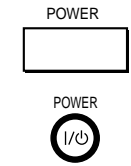

To change LCD brightness

Press **DIMMER** on the remote control.



4 pre-selected brightness levels are provided.

To adjust the volume of the speakers or the connected headphones

Turn volume control.



To remove the disc

Press the disc cover open button on the main unit to open the disc cover.



Remove the disc from under the rim while gently pressing down on its center.

CAUTION
 Do not touch the spindle immediately after prolonged play, as it may have become hot.
 Be careful in loading/removing a disc.

■ To change LCD mode

Press **LCD MODE** on the main unit

LCD MODE



Each time you press LCD MODE, the LCD mode (picture size) changes as follows.

Picture for playing	LCD MODE
<p>4:3 picture size</p>	<p>Normal (Masking bars appear on both sides of the picture)</p> <p>Cinema (Enlarged to fit the screen and eliminate/reduce letterbox bands on video)</p> <p>Wide (Stretched horizontally)</p> <p>Off</p>
<p>16:9 (widescreen) picture size</p>	<p>Normal</p> <p>Off</p>
<p>4:3LB (letterbox) picture size</p>	<p>Normal (Masking bars appear around the picture.)</p> <p>Cinema (Full display)</p> <p>Wide (Stretched horizontally)</p> <p>Off</p>

Note

In the cinema mode, the picture will be stretched when displayed on the LCD monitor. Comparing with the original one, the picture may be viewed vague. It is not abnormal.

■ About the screen saver

If you pause a picture of a DVD video disc and leave it still for a long while, the screen saver of the player automatically appears (when "Screen Saver" is set to "On" **[49]**). To turn off the screen saver, press the **PLAY** button on the main unit or remote control.

■ Automatic Power Off function

If the player is stopped, or the screen saver is engaged for approximately 20 minutes, the player will automatically turn itself off.

■ About the LCD

- The color LCD is manufactured using extremely high precision technology, but even so may include certain pixels that do not operate properly (that do not light, that remain lit constantly, etc.). We do our best to keep the number of these defective pixels to a minimum, but please understand that they cannot be completely eliminated even with the most advanced manufacturing technologies available today.
- The fluorescent tube which illuminates the panel from the inside will deteriorate with use. (The standard life length is about 10,000 hours of continuous use at normal temperature.) When the LCD becomes dim, flickers, or does not illuminate, contact your dealer for replacement.

When you view pictures on the LCD of this player, set the "TV Shape" to "16:9 Widescreen". **[46]**

Variable Speed Playback

You can play discs at various speeds, and resume playback from the location where you stopped playback.

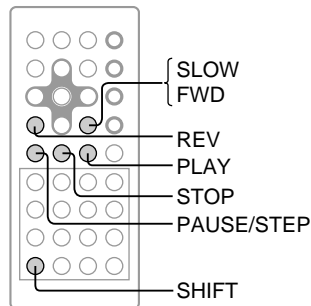

DVD VCD CD Playing in fast reverse or fast forward directions

Press REV or FWD on the remote control during playback.



REV: Fast reverse playback
FWD: Fast forward playback



Each time you press the REV or FWD button, the playback speed changes.

Press and hold SKIP (◀◀ / ▶▶) on the main unit during playback.

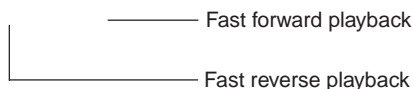

During the fast forward or fast reverse playback, you can vary the speed by pressing the button repeatedly.

■ To resume normal playback

Press **PLAY**.



Notes

- The player mutes sound and omits subtitles during reverse and forward scan of DVD video discs. However, the player plays sound during fast forward or fast reverse play of audio CDs.
- The speed of the fast forward or fast reverse playback may vary depending on the disc.

DVD VCD Playing frame by frame

Press PAUSE/STEP during still playback.



Each time you press the PAUSE/STEP button, the picture advances one frame.

■ To resume normal playback

Press **PLAY**.



Note

The sound is muted during frame by frame playback.

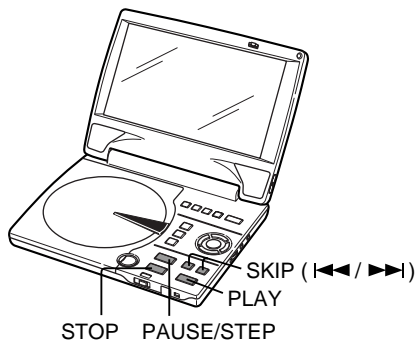

DVD VCD **Playing in slow-motion**

Press SLOW while pressing SHIFT during playback.



Each time you press the SLOW button, the slow-motion speed changes.

To resume normal playback

Press **PLAY**.



Note

The sound is muted during slow-motion playback.

DVD VCD CD **Resuming playback from the same location**

1 Press STOP at the location where you want to interrupt playback.



The player memorizes the location where playback is stopped.

To start playback from the beginning regardless of the location where you stopped playback

1 Press **STOP** twice.



The player's memory is cleared.

2 Press PLAY.



The player resumes playback from the location where you stopped playback.

2 Press **PLAY**.



DVD Playback starts from the beginning of the current title.

VCD CD Playback starts from the beginning of the disc.

- If you want to return to the beginning of a DVD video disc, turn the power off and on by pressing the **POWER** button, and then start playback.

Notes

- The player's memory is also cleared when:
 - you change the parental lock setting **[50]** or select a disc menu language **[48]**.
 - you use a PBC-featured VIDEO CD while "PBC" is set to "On" **[51]**.
- There may be a difference in the location where playback resumes depending on the disc.
- Settings you changed using the on-screen displays while the player keeps a location in the memory may function only after the memory is cleared.

Locating a Specific Title, Chapter, or Track

Normally, DVD video discs are divided into titles, and the titles are sub-divided into chapters. VIDEO CDs and audio CDs are divided into tracks. You can quickly locate any specific title, chapter, or track.

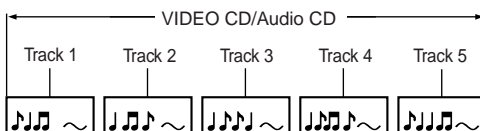
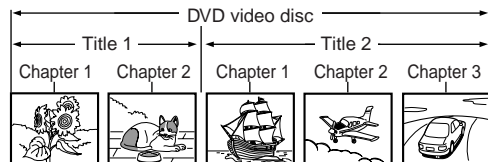

DVD Locating a title using the top menu

1 Press TOP MENU.

TOP MENU



The top menu appears.

e.g.

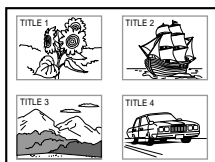

2 Press ▲/▼/◀/▶ to select the title you want.



If the titles in the top menu are assigned a number, you can directly locate a specific title by pressing its designated number with the number buttons.

3 Press ENTER.



Playback starts from chapter 1 of the selected title.

Notes

- The instructions above describe basic procedures which may vary depending on the contents of the DVD video disc. If different instructions appear on the screen, follow those instructions.
- If you display the top menu during playback and press the TOP MENU button again without selecting any title, the player may resume playback from the point where you first pressed the TOP MENU button (depending on the actual DVD video disc.)
- This method of locating a title is available only on a disc that contains a top menu.
- Instruction notes of discs may refer to the button that displays the top menu as TITLE button.

DVD Locating a title by entering the title number

1 Press T.



Make sure that the space of "T (Title)" is highlighted. (You can shift the highlight using the ◀/▶ buttons.)

e.g.



2 Enter the number for the title you want, using ▲/▼ or the number buttons.

e.g. To select title 2



To select title 12

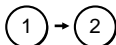

3 Press PLAY.

PLAY



Playback starts from chapter 1 of the selected title.

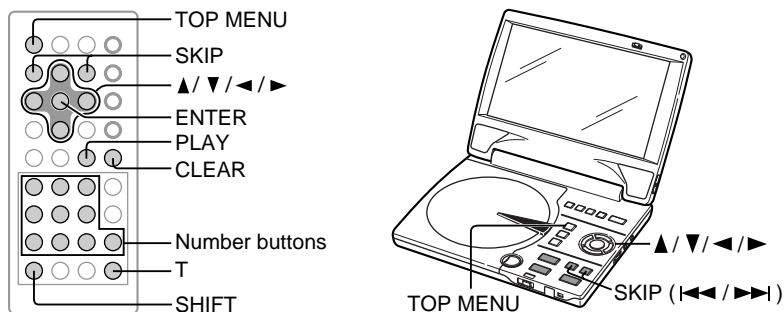

Notes

- Pressing the CLEAR button while pressing the SHIFT button resets the title and chapter numbers. To clear the "T (Title)" and "C (Chapter)" display, press the T button several times.
- This method of locating a title is available only on a disc that contains title numbers.





DVD VCD CD **Locating a specific chapter or track directly**

1 Press T.

 e.g. 



2 Press ▶ to highlight the space of "C (Chapter)."





 e.g. 

3 Enter the number for the chapter or track you want, using ▲ / ▼ or the number buttons.

You can use the +10 button to select numbers from 10 through 99.

e.g. To select chapter or track 25

 → 

or  +  →  +  → 

4 Press PLAY.

 Playback starts from the selected chapter or track.

■ To select a title and chapter number at the same time

Perform step 1, and enter a title number you want in the space next to "T (Title)" using ▲ / ▼ or the number buttons, then perform steps 2 to 4.

- Notes**
- Pressing the CLEAR button while pressing the SHIFT button resets the title and chapter numbers. To clear the "T (Title)" and "C (Chapter)" display, press the T button several times.
 - If you are using a VIDEO CD/audio CD, skip steps 1 and 2, then at step 3, enter the number for the track you want using the number buttons, and go to step 4.

DVD VCD CD **Locating a specific chapter or track**

Press SKIP (◀◀/▶▶) repeatedly to display the chapter or track number you want.

Playback starts from the selected chapter or track.

 To locate succeeding chapters or tracks.

 Playback starts from the beginning of the current chapter or track. When you press twice, playback starts from the beginning of the preceding chapter or track.

- Notes**
- Some titles may not display chapter numbers.
 - When you set "Title Stop" to "Off" , you can access chapters in another title. If you go back to the preceding title by pressing the SKIP ◀◀ button, the player locates the first chapter of the title. When "Title Stop" is set to "On," you can access chapters only within the current title.

Advanced playback

Customizing the performance of your player.

- **Accessing a Specific Location Directly**
- **Playing Repeatedly**
- **Playing in a Favorite Order**
- **Playing in Random Order**
- **Zooming a Picture**
- **Selecting the Picture Enhancement (E.P.M.)**
- **Selecting the Sound Enhancement (E.A.M.)**
- **Selecting a Camera Angle**
- **Selecting Subtitles**
- **Selecting a Language**
- **Operating in the On-screen Display mode**

Accessing a Specific Location Directly

You can access a specific location by entering its corresponding time (hours, minutes, seconds).

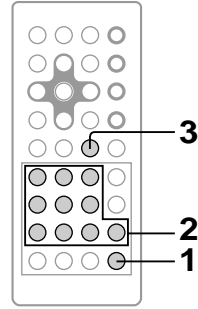

DVD VCD CD **Entering the time counter of the desired location**

1 Press T.

 You may have to press further depending on the disc. Press the button repeatedly until the clock icon is highlighted.

e.g. 

2 Press the number buttons to enter the time.

e.g.





3 Press PLAY.

 Playback starts from the desired location.

- Notes**
- Some discs may not respond to this process.
 - Some scenes may not be located precisely as you specified.
 - This method for accessing specific locations is available only within the current title of the DVD video disc or within the current track of the VIDEO CD/audio CD.

Playing Repeatedly

You can play a specific title, chapter, track, or segment repeatedly. (Title repeat, chapter/track repeat, A-B repeat)

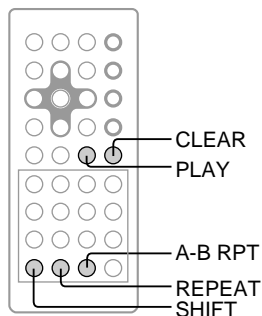
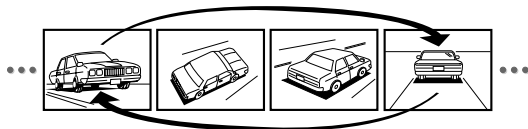

DVD VCD CD Repeating a title, chapter, or track

1 Press REPEAT.



Each time you press the REPEAT button, the repeat mode changes as follows.

Chapter Repeat

Chapter Repeat	Repeats the same chapter.
↓	
Title Repeat	Repeats the same title.
↓	
Track Repeat	Repeats the same track.
↓	
All Repeat	Repeats the entire disc.
↓	
Repeat Off	Resumes normal playback.

2 Press PLAY.



The player starts repeat playback. Press the PLAY button within about 5 seconds after you press the REPEAT button.

■ To resume normal playback

Press **CLEAR** while pressing **SHIFT**.



Note

Some discs may not permit repeat operation.

Advanced playback

DVD VCD CD Repeating a specific segment

1 Press A-B RPT at the beginning of the segment (point A) you want to play repeatedly.



A-

2 Press A-B RPT again at the end of the segment (point B).



The player automatically returns to point A and starts repeat playback of the selected segment (A-B).

A-B

■ To resume normal playback

Press **CLEAR** while pressing **SHIFT**.



Notes

- Some discs may not permit A-B repeat operation.
- You can specify a segment only within the current title or track.
- You cannot set the A-B repeat function for a segment that includes multiple camera angles **37**.
- There may be a slight difference between point A and the location where playback actually resumes depending on the disc.

Playing in a Favorite Order

You can combine your favorite titles, chapters, or tracks and play them in the order you determine. You can program up to 30 selections into the memory. (Memory playback)

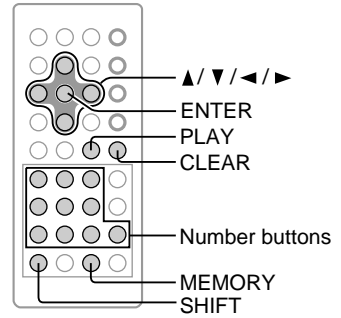

DVD VCD CD Setting titles, chapters, or tracks in a favorite order

1 Set a disc and press MEMORY while pressing SHIFT during stop.



The following display appears.

T: Title number
CT: Chapter number or track number

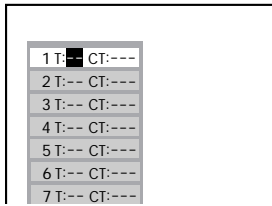

2 Select the items in the order you want by pressing the number buttons, then ENTER for each item.

Each time you press the ◀/▶ button, the space of "T" and "CT" is highlighted in turn. Highlight where you want to enter, then press the corresponding number buttons.

To select another chapter in the same title, you do not need to select the title number.

To select tracks from a VIDEO CD/audio CD in order, press the number buttons for the track, then press the ENTER button for each selection you want.

Note

The space of "T (Title)" may be showing a number. Neglect this number when using a VIDEO CD/audio CD.

3 Press PLAY while the display appears on the screen.



The player starts memory playback.

■ To change the programmed selections

- 1 While the display appears on the screen, press ▲/▼ to move the highlighted bar to the item you want to change.
- 2 Change the selection following the instructions in step 2.

■ To cancel the programmed selections

- 1 While the display appears on the screen, press ▲/▼ to move the highlighted bar to the item you want to cancel.
- 2 Press CLEAR while pressing SHIFT.

■ To resume normal playback from memory playback

Press CLEAR while pressing SHIFT.

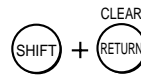

■ To program during playback

If you press the MEMORY button while pressing the SHIFT button during playback, a programming display appears. Follow steps 2 and 3.

Notes

- Some discs may not permit memory playback operation.
- If you press the REPEAT button during memory playback, the player repeats the current memory playback.
- When the display appears on the screen, if you press the RETURN button or press the MEMORY button while pressing the SHIFT button, the display disappears.
- The programmed selections will be cleared when you turn off the player.

Playing in Random Order

You can play titles, chapters within a title, or tracks in random order. (Random playback)

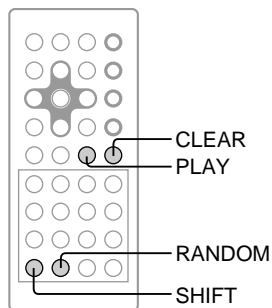

DVD VCD CD Playing titles, chapters or tracks in random order

1 Press RANDOM while pressing SHIFT.



Each time you press the RANDOM button, the random mode changes as follows.

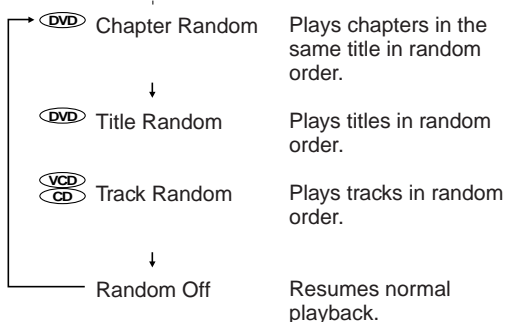
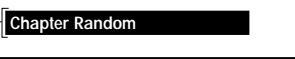

If you press the RANDOM button during playback, the player automatically starts random playback after finishing the current title, chapter or track.

2 Press PLAY.



The player starts random playback. Press the PLAY button within about 5 seconds after you press the RANDOM button.

■ To resume normal playback

Press CLEAR while pressing SHIFT.



Notes

- Some discs may not permit random playback operation.
- You cannot use the random playback function in conjunction with the memory playback feature.

Zooming a Picture

You can magnify areas within a picture.

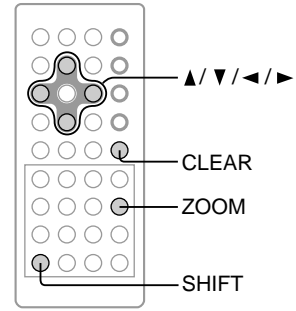
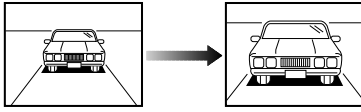

DVD Zooming a picture

Press ZOOM, while pressing SHIFT during normal, slow or still playback.



The DVD video player enters the zoom playback mode and displays the icon.

e.g.

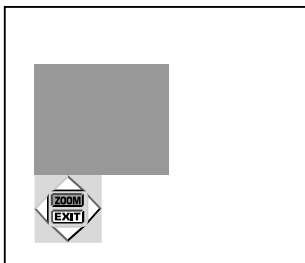

ZOOM : As you repeatedly press the ENTER (or ZOOM while pressing SHIFT) button while "ZOOM" is selected, the magnification level changes. Variation of the levels includes image reduction.

EXIT : If you press the ENTER button while "EXIT" is highlighted, you can turn off the icon, keeping the current magnification level.

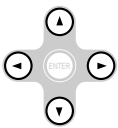

You can shift the highlight within the icon by the ▲ / ▼ / ◀ / ▶ buttons.

If you press and hold the ▲ / ▼ / ◀ / ▶ buttons, the zoom point shifts.



Pressing the CLEAR button while pressing the SHIFT button restores the zoom point to the center of the picture.

To resume normal playback

While "ZOOM" is selected, press ENTER repeatedly to turn off the icon.

Picture restores the size when the icon disappears.



- The ENTER button cannot cancel zoom playback if you have turned off the icon by selecting "EXIT." To restore normal picture size, press the ZOOM button to display the icon, then press the ENTER button until the icon turns off.

Notes

- Some discs may not respond to zoom feature.
- During some scenes, the buttons may not work as described.
- Zooming does not work on subtitles or menus included on DVD video discs.
- While the icon is displayed, the ▲ / ▼ / ◀ / ▶ buttons cannot work on menus included on the DVD video discs. If you want to view the menus, turn off the icon.
- The magnification level varies depending on the picture size you select. **46**

Selecting the Picture Enhancement (E.P.M.*)

You can easily select a preferred picture enhancement.

*E.P.M.: Enhanced Picture Mode

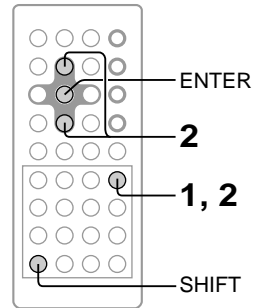

DVD VCD CD Selecting the picture enhancement

1 Press E.P.M. while pressing SHIFT.



The picture enhancement menu appears.

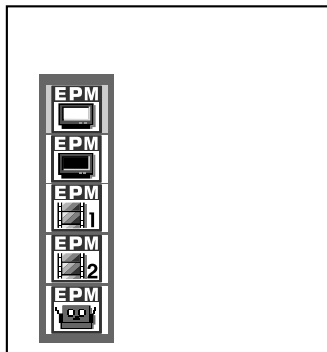

2 Select the picture enhancement by pressing E.P.M. while pressing SHIFT or by pressing ▲ / ▼.

Each time you press the button, the picture enhancement changes.



Normal:
Standard black level (7.5 IRE).



Enhanced Black Level:
Enhanced Black Level (0 IRE).



Movie 1:
Brightness levels raised for enhanced picture quality.



Movie 2:
For deeper, richer color reproduction.



Animation:
For enhanced color contrast.

To exit the picture enhancement selection

Press ENTER.



Alternatively leave the DVD video player unattended for about 5 seconds after having made a selection.

Note

Actual effects to picture may vary depending on the TV. Make selection according to your preference.

Selecting the Sound Enhancement (E.A.M.*)

You can easily select a preferred audio enhancement.

*E.A.M.: Enhanced Audio Mode

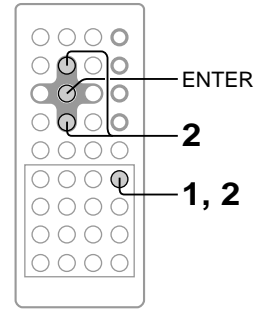

DVD VCD CD Selecting the sound enhancement

1 Press E.A.M.



The sound enhancement menu appears. You can also use the E.A.M. button on the main unit.

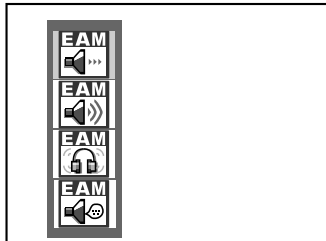

2 Select the sound enhancement by pressing E.A.M. or ▲ / ▼.

Each time you press the button, the sound enhancement changes.



Normal:
Normal sound.



3D (N-2-2): *
To obtain expansive virtual surround sound effects from just two speakers.



3D headphone (N-2-2): *
To obtain expansive virtual surround sound effects when using headphone.



Dialogue:
To control critical center channel information to make dialogue more intelligible (only when playing a DVD video disc recorded on the Dolby Digital recording system).

- To use this enhancement on sounds output from the BITSTREAM/PCM jack, be sure to set "Audio Out Select" to "PCM." **47**

To exit the audio enhancement selection

Press ENTER.

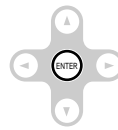

Alternatively leave the DVD video player unattended for about 5 seconds after having made a selection.

Notes

- Actual effects to sounds may vary depending on the speaker system. Make the selection to your preference.
- Actual effects to sounds may vary depending on the disc.
- When the DVD video player is connected to an amplifier equipped with Dolby Pro Logic Surround, select "Normal". Otherwise, Dolby Pro Logic Surround may function differently than usual.
- Selecting "Dialogue" disables the "Dynamic Range Control" function **47**.

* Spatializer® 3-Dimensional Sound Processing provided by Desper Products, Inc. Certain audio features of this product manufactured under a license from Desper Products, Inc., Spatializer® and the circle-in-square device are trademarks owned by Desper Products, Inc.

Selecting a Camera Angle

If a scene was recorded with multiple angles, you can easily change the camera angle of the scene you are viewing.

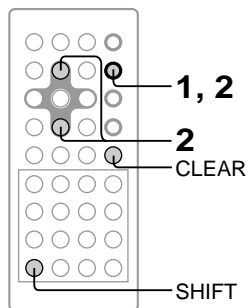
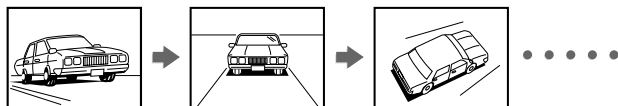

DVD Changing the camera angle

1 Press ANGLE while playing a scene recorded with multiple angles.



While playing a scene recorded with multiple angles, the angle icon (📷) appears on the screen. Press the ANGLE button while the angle icon is displayed.

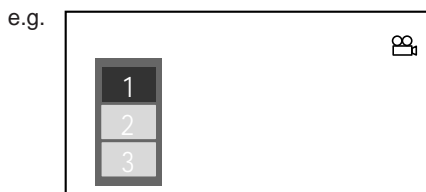

■ To turn off the angle number display

Press **CLEAR** while pressing **SHIFT**.



Notes

- After selecting angle, it will take a few minutes to change the camera angle of the scene you are viewing.
- You can change the camera angle during still playback. The camera angle changes to the new setting when you resume normal playback.
- If you pause a picture immediately after changing a camera angle, the resumed playback picture may not display the new camera angle.

2 Press ANGLE or ▲ / ▼ while the angle number is displayed on the screen.



Each time you press the ANGLE or ▲ / ▼ buttons, the camera angle changes.

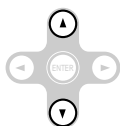

You can change the camera angle directly by pressing the number buttons corresponding to an angle number instead of using the ▲ / ▼ buttons.

Selecting Subtitles

You can display subtitles on the screen and select a subtitle language from those included on the DVD video disc.

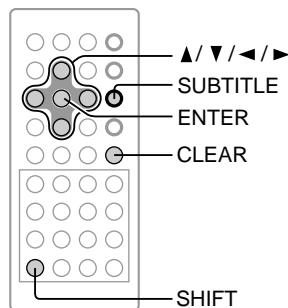
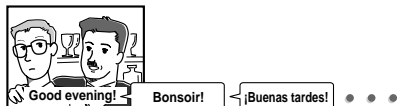

DVD Selecting a subtitle language

1 Press SUBTITLE during playback.



The current subtitle setting is displayed.

e.g.



The abbreviation of the language appears instead of the language name. Refer to the list of languages and their abbreviations. [53](#)

2 Press SUBTITLE or ▲ / ▼ while the subtitle setting is displayed on the screen.



Each time you press the SUBTITLE or ▲ / ▼ button, the subtitle languages included on the DVD video disc change.



To turn off the subtitle setting display, press the ENTER button, or press the CLEAR button while pressing the SHIFT button.

To turn subtitles on or off

1 Press SUBTITLE during playback.



2 Press ◀ / ▶ while the subtitle setting is displayed on the screen, to select "On" or "Off."

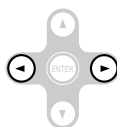

Notes

- Some DVD video discs display subtitles automatically, and you cannot turn them off even if you set the subtitle function to off.
- During some scenes, subtitles may not appear immediately after you select "On."
- Some DVD video discs will allow you to make subtitle selections and turn subtitles on or off only via the disc menu.

Notes

- When you turn on the player or replace a disc, the player returns to the initial default setting [48](#).
- When you select a subtitle language which is not included on the disc, the player plays a prior language programmed on the disc.
- During some scenes, the subtitles may not appear immediately after you change the subtitle language by pressing the ▲ / ▼ buttons.

Selecting a Language

You can select a preferred language and sound recording system from those included on the DVD video disc.

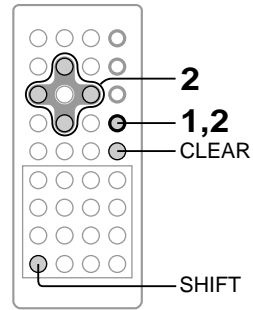
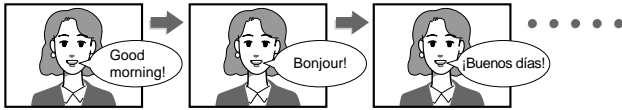

DVD VCD Selecting a playback audio setting

1 Press AUDIO during playback.



The current audio setting is displayed.

e.g.



The abbreviation of the language appears instead of the language name. Refer to the list of languages and their abbreviations. **53**

2 Press AUDIO or ▲ / ▼ while the audio setting is displayed on the screen.



Each time you press the AUDIO or ▲ / ▼ button, the audio settings included on the DVD video disc change.

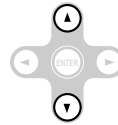

If you press the ◀ / ▶ buttons, you can select output sound format.

To turn off the audio setting display, press the CLEAR button while pressing the SHIFT button or press the ENTER button.

Selecting sound channels of VIDEO CDs

During playback, press **AUDIO** repeatedly to select the sound channel.



Notes

- Some discs allow you to change audio selections only via the disc menu. If this is the case, press the MENU button and choose the appropriate language from the selections on the disc menu.
- When you turn on the player or replace a disc, the player returns to the initial default setting **48**. If you select a sound track which is not included on the disc, the player plays a prior sound track programmed on the disc.

Output sound conversion table (sampling frequency/quantization bit)

Discs	Recording system	Audio selection from the menu 44 47 and output jacks on the rear panel					
		"Bitstream"		"Analog 2ch"		"PCM"	
		BITSTREAM/PCM jack	AV OUT jack	BITSTREAM/PCM jack	AV OUT jack	BITSTREAM/PCM jack	AV OUT jack
DVD video discs	Dolby Digital	Bitstream	48 kHz/20 bit	Bitstream	48 kHz/16 bit	48 kHz/16 bit	48 kHz/20 bit
	Linear PCM	48 kHz/16 bit	48 kHz/16 bit	48 kHz/16 bit	48 kHz/16 bit	48 kHz/16 bit	48 kHz/16 bit
		48 kHz/20 bit	48 kHz/16 bit	48 kHz/20 bit	48 kHz/16 bit	48 kHz/20 bit	48 kHz/16 bit
		48 kHz/24 bit	48 kHz/16 bit	48 kHz/24 bit	48 kHz/16 bit	48 kHz/24 bit	48 kHz/16 bit
		96 kHz/16 bit	48 kHz/16 bit	48 kHz/16 bit	—	96 kHz/16 bit	48 kHz/16 bit
		96 kHz/20 bit	48 kHz/16 bit	48 kHz/20 bit	—	96 kHz/20 bit	48 kHz/16 bit
	96 kHz/24 bit	48 kHz/16 bit	48 kHz/24 bit	—	96 kHz/24 bit	48 kHz/16 bit	
DTS	Bitstream	—	Bitstream	—	—	—	
MPEG2	Bitstream	48 kHz/16 bit	Bitstream	48 kHz/16 bit	48 kHz/16 bit	48 kHz/16 bit	
VIDEO CDs	MPEG1	44.1 kHz/16 bit	44.1 kHz/16 bit	44.1 kHz/16 bit	44.1 kHz/16 bit	44.1 kHz/16 bit	44.1 kHz/16 bit
Audio CDs	Linear PCM 44.1 kHz/16 bit	44.1 kHz/16 bit	44.1 kHz/16 bit	44.1 kHz/16 bit	44.1 kHz/16 bit	44.1 kHz/16 bit	44.1 kHz/16 bit
	DTS	Bitstream	(Noise)	Bitstream	(Noise)	Bitstream	(Noise)

■ : 3-D (N-2-2) sound enhancement can function.

Operating in the On-screen Display Mode

When you turn on the on-screen display, you can view information on operational status and access features and settings.

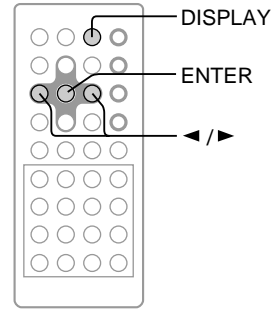

DVD VCD CD On-Screen Display Operation

Press DISPLAY.



The following display appears. You can also use the DISPLAY button on the main unit. Each time you press the DISPLAY button, the on-screen display changes as follows. If you press the ◀/▶ buttons to select an icon, then press the ENTER button, you can access the specific feature. When you select an icon (*), there is no need to press the ENTER button. See the pages in □ for details on the features.

e.g. When playing a DVD video disc

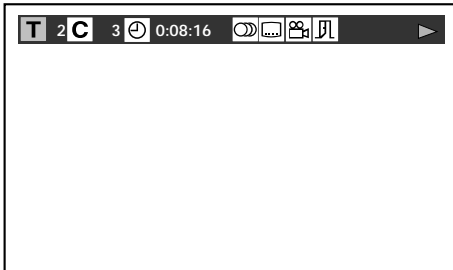

Press DISPLAY again.



Press DISPLAY again.



- T** * : Title number (Track number)
Locate a title or track using the number buttons. **26** **27**
- C** * : Chapter number
Locate a chapter using the number buttons. **27**
- ⌚** * : Elapsed time of the current title
To enter the time to locate a desired location. **30**
- 🔊** : Audio setting **39**
- ☰** : Subtitle setting **38**
- 🎥** : Angle setting **37**
- 🔌** : To turn off the display.
- T** * : Title number (Track number)
Locate a title or track using the number buttons. **26** **27**
- C** * : Chapter number
Locate a chapter using the number buttons. **27**
- ⌚** * : Remaining time of the current title
To enter the time to locate a desired location. **30**
- EAM** : E.A.M. (Enhanced Audio Mode) setting **36**
- EPM** : E.P.M. (Enhanced Picture Mode) setting **35**
- ZOOM** : To zoom a picture. **34**
- 🔊** : "Audio Out Select" setting **39**
BST: Bitstream 2CH: Analog 2ch PCM: PCM
- 🔌** : To turn off the display.

(continued)

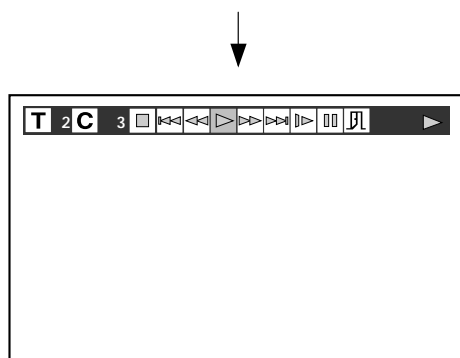



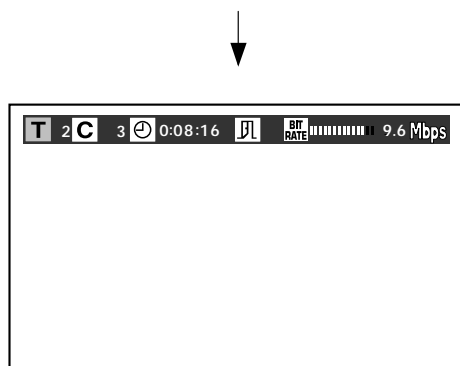





Press DISPLAY again.



Press DISPLAY again.

The on-screen display disappears.

- T** * : Title number (Track number)
Locate a title or track using the number buttons. **26** **27**
- C** * : Chapter number
Locate a chapter using the number buttons. **27**
-  : To stop playback. **22**
-  : Playback starts from the beginning of the current chapter or track. **27**
-  : Fast reverse playback **24**
-  : To start playback. **20**
-  : Fast forward playback **24**
-  : To locate succeeding chapters or tracks. **27**
-  : To begin slow motion playback. **25**
-  : To pause playback. **22**
-  : To turn off the display.

The on-screen display will vary depending on the disc.

(DVD) : Data transfer rate (Mbit/s)
= Amount of picture, sound and subtitle data in the DVD video disc transferred per second.
The larger the value is, the more data processed, but this does not necessarily insure better picture quality.

(CD) : CD-Text
Displays CD-Text data if included on the audio CDs. (Some letters may not be displayed properly depending on the disc.)

(VCD) : The on-screen display turns off.

Function Setup

You can change the default settings to customize performance to your preference.

- **Customizing the Function Settings**
- **Table of Languages**

Customizing the Function Settings

You can change the default settings to customize performance to your preference.

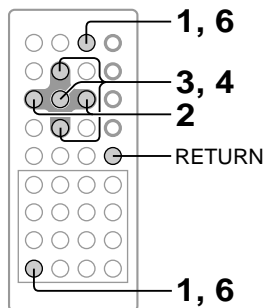

DVD VCD CD Setting procedure

1 Press **SETUP** while pressing **SHIFT** during stop. (For the main unit, only press **SETUP**.)



The following on-screen display appears.

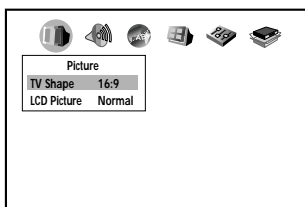

2 Press **◀/▶** to select a symbol for the setting you want to change.

(See the next page.)



Picture performance settings



Output sound settings



Language settings



Display settings



Operational settings



Initial settings

3 Press **▲/▼** to select the setting you want to change, then press **ENTER**.

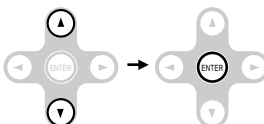

4 Change the selection by **▲/▼** or other buttons, by referring to the corresponding pages **46**, then press **ENTER**.

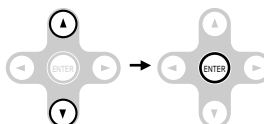

5 Repeat steps 3 and 4 to change other settings.

To select another operation, go back to step 2.

6 Press **SETUP** while pressing **SHIFT**. (For the main unit, only press **SETUP**.)



The on-screen display disappears.

■ To return to the previous display









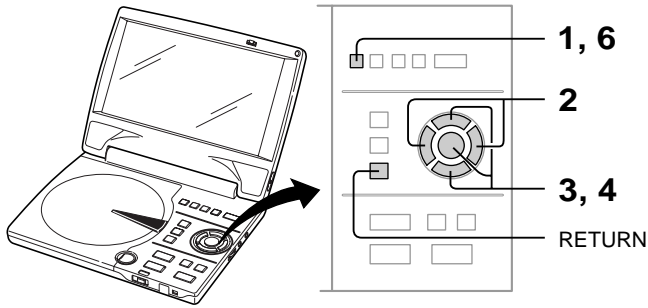

























Press **RETURN**.



Notes

- The on-screen display disappears when you press the **SETUP** button while pressing the **SHIFT** button. (For the main unit, only press **SETUP**.)
- The **SETUP** button can function even during normal playback, however some operations may be inaccessible, and a message will appear. In this case, try again after playback is stopped.



Setting	Details	Page
	TV Shape  To select a picture size according to the aspect ratio of your TV.	46
	LCD Picture   To select the picture quality of the LCD.	46
	Audio Out Select    To select an output sound format corresponding to your system connection.	47
	Dynamic Range Control  To turn on or off a function that makes faint sounds easier to hear even if you lower the volume during late hours playback.	47
	Karaoke Vocal  To turn on or off the vocal output during DVD KARAOKE disc playback.	47
	On-Screen Language    To select a preferred language for on-screen displays.	48
	Disc Menu Language  To select a preferred language for disc menus.	48
	Audio Language  To select a preferred language for the sound track.	48
	Subtitle Language  To select a preferred language for subtitles.	48
	On-Screen Displays    To turn on or de-activate the operational status display on the screen.	49
	Background    To select the background color for on-screen displays.	49
	Screen Saver  To turn the screen saver on or off.	49
	Pause/Still  To select the resolution of still pictures. (Field/Frame)	50
	Parental Lock  To turn the parental lock function on or off.	50
	Title Stop  To turn on or off a feature that automatically stops playback after a title has been viewed.	51
	PBC  To use the menu when playing a PBC-featured VIDEO CD.	51
	On-Screen Language  To install the initial system setting.	52
	TV Shape 	
	Audio Out Select 	

Customizing the Function Settings (continued)

Setting details

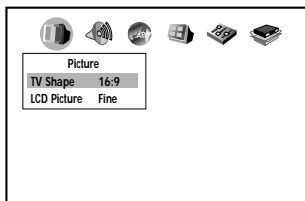
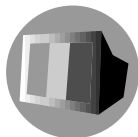

TV Shape DVD

4:3 Letterbox: Select when a standard 4:3 TV is connected. Displays theatrical images with masking bars above and below the picture.



4:3 Normal: Select when a standard 4:3 TV is connected. Displays pictures cropped to fill your TV screen. Either or both sides of the picture are cut off.



16:9 Widescreen: Select when a 16:9 wide TV is connected.

Notes

- The displayable picture size is preset on the DVD video disc. Therefore, the playback picture of some DVD video discs may not conform to the picture size you select.
- When you play DVD video discs recorded in the 4:3 picture size only, the playback picture always appears in the 4:3 picture area regardless of the TV shape setting.
- If you select "16:9 Widescreen" and you own a 4:3 TV set, the DVD playback picture will be horizontally distorted during playback. Images will appear to be horizontally compressed. Always be sure that your TV shape conforms to the actual TV in use.
- When you view pictures on the LCD of this player, select "16:9 Widescreen".

LCD Picture DVD VCD

Select the picture quality of LCD.

Fine: Picture resolution is enhanced.

Normal: Picture resolution is normal.

Notes

- When you select "Fine", picture will not be output from the video output. When you connect the player to a TV set, close up the LCD or press the LCD MODE button on the main unit to turn the LCD monitor off. **[23]**
- Always select "Normal" when connecting the player to an external display via the video output(s).

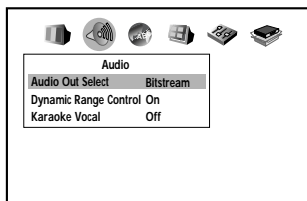

Audio Out Select DVD VCD CD

Select the output sound format corresponding to your system connection.

For details of sound recording systems, see [39](#).

Bitstream: Select when connected to an amplifier equipped with a Dolby Digital, DTS, MPEG1 or MPEG2 decoder. [58](#) [59](#)
The player outputs digital audio information in the bitstream format when you play a DVD video disc recorded on the Dolby Digital, DTS, MPEG1 or MPEG2 recording system.

Analog 2ch: Select when connected to a TV, or Dolby Pro Logic or stereo system via the analog audio jacks. [56](#) [58](#)

PCM: Select when connected to a 2 channel digital stereo amplifier. [59](#)
The player outputs sounds in the PCM 2ch format when you play a DVD video disc recorded on the Dolby Digital, MPEG1 or MPEG2 recording system.

Dynamic Range Control DVD

Turn on or off a function that makes faint sounds easier to hear. Especially beneficial, if you lower the volume during late hours playback.

Off: Full dynamic range is maintained.

On: Dynamic range is reduced.

Notes

- This function works only during playback of Dolby Digital recorded discs.
- The level of Dynamic Range Reduction may differ depending on the DVD video disc.

Karaoke Vocal DVD

Off: The primary vocal is not output.

On: The primary vocal is output when it is recorded on the disc.

Notes

- The vocal output feature is used during playback of Dolby Digital (multi-channel) recorded DVD KARAOKE discs. This feature allows you to turn off vocal audio tracks, or restore them for background accompaniment.
- When playing KARAOKE, connect appropriate audio equipment such as an amplifier to the player.

Customizing the Function Settings (continued)

Setting details

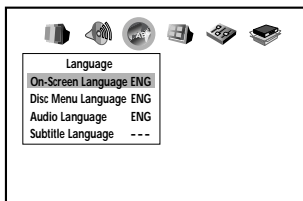

On-Screen Language (DVD VCD CD)

English: To view on-screen displays in English.
 Français: To view on-screen displays in French.
 Español: To view on-screen displays in Spanish.

Disc Menu Language (DVD)

English: To display disc menus in English.
 French: To display disc menus in French.
 Spanish: To display disc menus in Spanish.
 Others: To make a further choice.

After pressing the ENTER button, follow steps 1) - 4) below.

- 1) Obtain the abbreviation of the preferred language from the list **[53]**.
- 2) Select the first character by pressing the ▲ / ▼ buttons.
- 3) Press the ◀ / ▶ buttons to shift and select the second character by pressing the ▲ / ▼ buttons.

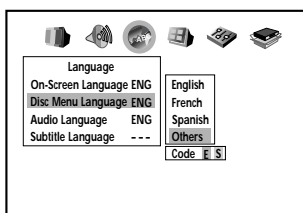

- 4) Press the ENTER button.

Note

Some DVD video discs may not include your pre-selected language. In this case, the player automatically displays disc menus consistent with the disc's initial language setting.

Audio Language (DVD)

English: To play sound tracks in English.
 French: To play sound tracks in French.
 Spanish: To play sound tracks in Spanish.
 Others: To make a further choice.

After pressing the ENTER button, follow steps 1) - 4) below.

- 1) Obtain the abbreviation of the preferred language from the list **[53]**.
- 2) Select the first character by pressing the ▲ / ▼ buttons.
- 3) Press the ◀ / ▶ buttons to shift and select the second character by pressing the ▲ / ▼ buttons.

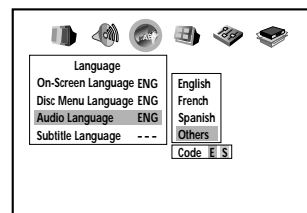

- 4) Press the ENTER button.

Note

Some DVD video discs may be played in a different language than you selected. A prior language may be programmed on the disc.

Subtitle Language (DVD)

English: To display subtitles in English.
 French: To display subtitles in French.
 Spanish: To display subtitles in Spanish.
 No Subtitle: To disable subtitles.
 Others: To make a further choice.

After pressing the ENTER button, follow steps 1) - 4) below.

- 1) Obtain the abbreviation of the preferred language from the list **[53]**.
- 2) Select the first character by pressing the ▲ / ▼ buttons.

- 3) Press the ◀/▶ buttons to shift and select the second character by pressing the ▲/▼ buttons.

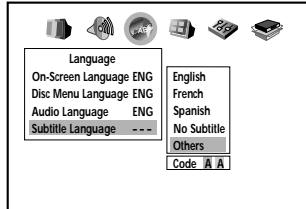

- 4) Press the ENTER button.

Notes

- Some DVD video discs may be set to display subtitles in a different language than you selected. A prior subtitle language may be programmed on the disc.
- Some DVD video discs allow you to change subtitle selections only via the disc menu. If this is the case, press the MENU button and choose the appropriate subtitle language from the selection on the disc menu.

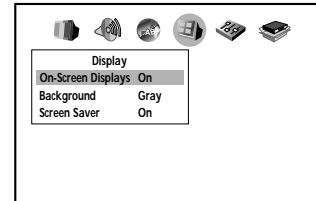

On-Screen Displays (DVD) (VCD) (CD)

Off: Operational modes (e.g. "□□", "▶▶") are not displayed.

On: Operational modes (e.g. "□□", "▶▶") are displayed on-screen.

Background (DVD) (VCD) (CD)

Blue: Blue background.

Gray: Gray background.

Picture: To use the picture which appears when you turn on the player as a background.

Jacket: To use the jacket picture included on some discs as a background. If it is not included, a gray background will be substituted.

Screen Saver (DVD)

Off: The screen saver is disengaged.

On: The screen saver operates.

Customizing the Function Settings (continued)

Setting details

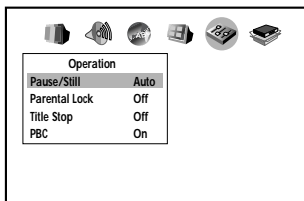
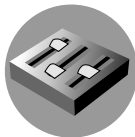

Pause/Still DVD

Auto: For normal use. Still and fast motion images can be paused.

Frame: The resolution of still pictures is improved, so that you can make a motionless picture sharper when you pause it.

Parental Lock DVD

DVD video discs equipped with the parental lock function are rated according to their content. The contents allowed by a parental lock level and the way a DVD video disc can be controlled may vary from disc to disc. For example, if the disc allowed you could edit out violent scenes unsuitable for children and replace them with more suitable scenes, or lock out playback of the disc altogether.

- DVD video discs may or may not respond to the parental lock settings. This is not a defect in the player. Make sure this function works with your DVD video discs.

Off: The parental lock feature does not function. After pressing the ENTER button, follow step 1) below.

On: To activate the parental lock feature or change the settings. After pressing the ENTER button, follow steps 1) - 3) below.

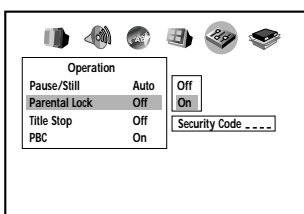

1) Press the number buttons to create a personal 4-digit security code, then press ENTER. If you make a mistake, before pressing the ENTER button, press the CLEAR button while pressing the SHIFT button and enter your 4-digit security code again.

2) Enter the code of a country/area whose standards were used to rate the DVD video disc, referring to the list below.

Country/Area	Code
AUSTRALIA	AU
BELGIUM	BE
CANADA	CA
CHINA	CN
CHINA HONG KONG	HK
DENMARK	DK
FINLAND	FI
FRANCE	FR
GERMANY	DE
INDONESIA	ID
ITALY	IT
JAPAN	JP
MALAYSIA	MY
NETHERLANDS	NL
NORWAY	NO
PHILIPPINES	PH
RUSSIAN FEDERATION	RU
SINGAPORE	SG
SPAIN	ES
SWEDEN	SE
SWITZERLAND	CH
TAIWAN	TW
THAILAND	TH
UNITED KINGDOM	GB
UNITED STATES	US

- Select the first character by pressing the ▲ / ▼ buttons.
- Press the ◀ / ▶ buttons to shift and select the second character by pressing the ▲ / ▼ buttons.
- Press the ENTER button.

- 3) Press the ▲ / ▼ button to select the parental lock level, then press the ENTER button.

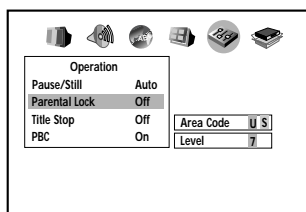

You cannot play DVD video discs rated higher than the level you selected unless you cancel the parental lock function.

For example, when you select level 7, discs rated higher than level 7 are locked out and cannot be played.

The parental lock level is equivalent to the following USA movie ratings.

- Level 7: NC-17
- Level 6: R
- Level 4: PG 13
- Level 3: PG
- Level 1: G

The parental lock levels for other countries/areas than U.S. are included for future use. Check the appropriate parental lock level when you buy a DVD video disc equipped with the parental lock feature in the future.

■ To change the parental lock level

Follow steps 1) - 3).

■ To change your 4-digit security code

- 1) After selecting "On" or "Off," press the STOP button four times, then press the ENTER button.

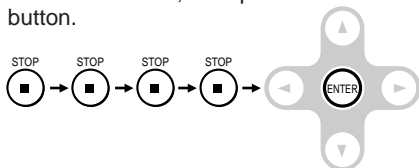

The 4-digit security code is cleared.

- 2) Press the number buttons to create a new 4-digit security code.
3) Press the ENTER button.

Title Stop

- Off: The player continues after playback of a title is completed.
On: The player stops after playback of a title is completed.

PBC

- Off: When playing a VIDEO CD without using the menu.
On: To use the menu when playing a PBC-featured VIDEO CD.

Customizing the Function Settings (continued)

Setting details

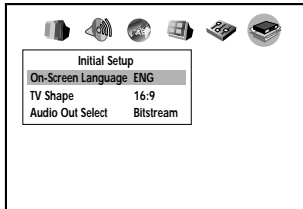
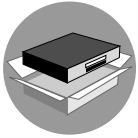

Initial Setup DVD VCD CD

- 1) Press the **▲** / **▼** buttons to select "On-Screen Language," and press the **ENTER** button.

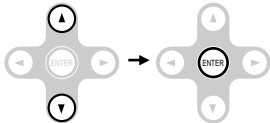

- 2) Select a language pressing the **▲** / **▼** buttons, and press the **ENTER** button.

See page [48](#), "On-Screen Language."

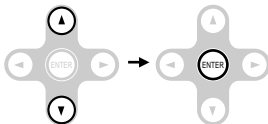

- 3) Make your selection in the same manner as step 1) then step 2).

See page [46](#), "TV Shape."

See page [47](#), "Audio Out Select."

Table of Languages

Table of languages and their abbreviations

Abbreviation	Language	Abbreviation	Language	Abbreviation	Language
---	No alternate language	GN	Guarani	PT	Portuguese
CHI (ZH)	Chinese	GU	Gujarati	QU	Quechua
DUT (NL)	Dutch	HA	Hausa	RM	Rhaeto-Romance
ENG (EN)	English	HI	Hindi	RN	Kirundi
FRE (FR)	French	HR	Croatian	RO	Rumanian
GER (DE)	German	HU	Hungarian	RU	Russian
ITA (IT)	Italian	HY	Armenian	RW	Kinyarwanda
JPN (JA)	Japanese	IA	Interlingua	SA	Sanskrit
KOR (KO)	Korean	IE	Interlingue	SD	Sindhi
MAY (MS)	Malay	IK	Inupiak	SG	Sango
SPA (ES)	Spanish	IN	Indonesian	SH	Serbo-Croatian
AA	Afar	IS	Icelandic	SI	Singhalese
AB	Abkhazian	IW	Hebrew	SK	Slovak
AF	Afrikaans	JI	Yiddish	SL	Slovenian
AM	Amharic	JW	Javanese	SM	Samoaan
AR	Arabic	KA	Georgian	SN	Shona
AS	Assamese	KK	Kazakh	SO	Somali
AY	Aymara	KL	Greenlandic	SQ	Albanian
AZ	Azerbaijani	KM	Cambodian	SR	Serbian
BA	Bashkir	KN	Kannada	SS	Siswati
BE	Belorussian	KS	Kashmiri	ST	Sesotho
BG	Bulgarian	KU	Kurdish	SU	Sundanese
BH	Bihari	KY	Kirghiz	SV	Swedish
BI	Bislama	LA	Latin	SW	Swahili
BN	Bengali, Bangla	LN	Lingala	TA	Tamil
BO	Tibetan	LO	Laotian	TE	Telugu
BR	Breton	LT	Lithuanian	TG	Tajik
CA	Catalan	LV	Latvian, Lettish	TH	Thai
CO	Corsican	MG	Malagasy	TI	Tigrinya
CS	Czech	MI	Maori	TK	Turkmen
CY	Welsh	MK	Macedonian	TL	Tagalog
DA	Danish	ML	Malayalam	TN	Setswana
DZ	Bhutani	MN	Mongolian	TO	Tongan
EL	Greek	MO	Moldavian	TR	Turkish
EO	Esperanto	MR	Marathi	TS	Tsonga
ET	Estonian	MT	Maltese	TT	Tatar
EU	Basque	MY	Burmese	TW	Twì
FA	Persian	NA	Nauru	UK	Ukrainian
FI	Finnish	NE	Nepali	UR	Urdu
FJ	Fiji	NO	Norwegian	UZ	Uzbek
FO	Faroese	OC	Occitan	VI	Vietnamese
FY	Frisian	OM	(Afan) Oromo	VO	Volapük
GA	Irish	OR	Oriya	WO	Wolof
GD	Scottish Gaelic	PA	Panjabi	XH	Xhosa
GL	Galician	PL	Polish	YO	Yoruba
		PS	Pashto, Pushto	ZU	Zulu

Connections

You can connect the player to a TV or audio system. Also, you can connect a battery pack to power the player.

- **Connecting to a TV**
- **Connecting to Headphones**
- **View Pictures of Video Equipment**
- **Connecting to Optional Equipment**
- **Using the battery pack**

Connecting to a TV

Connect the player to a TV to view playback pictures. For details of output sound, see [39](#).

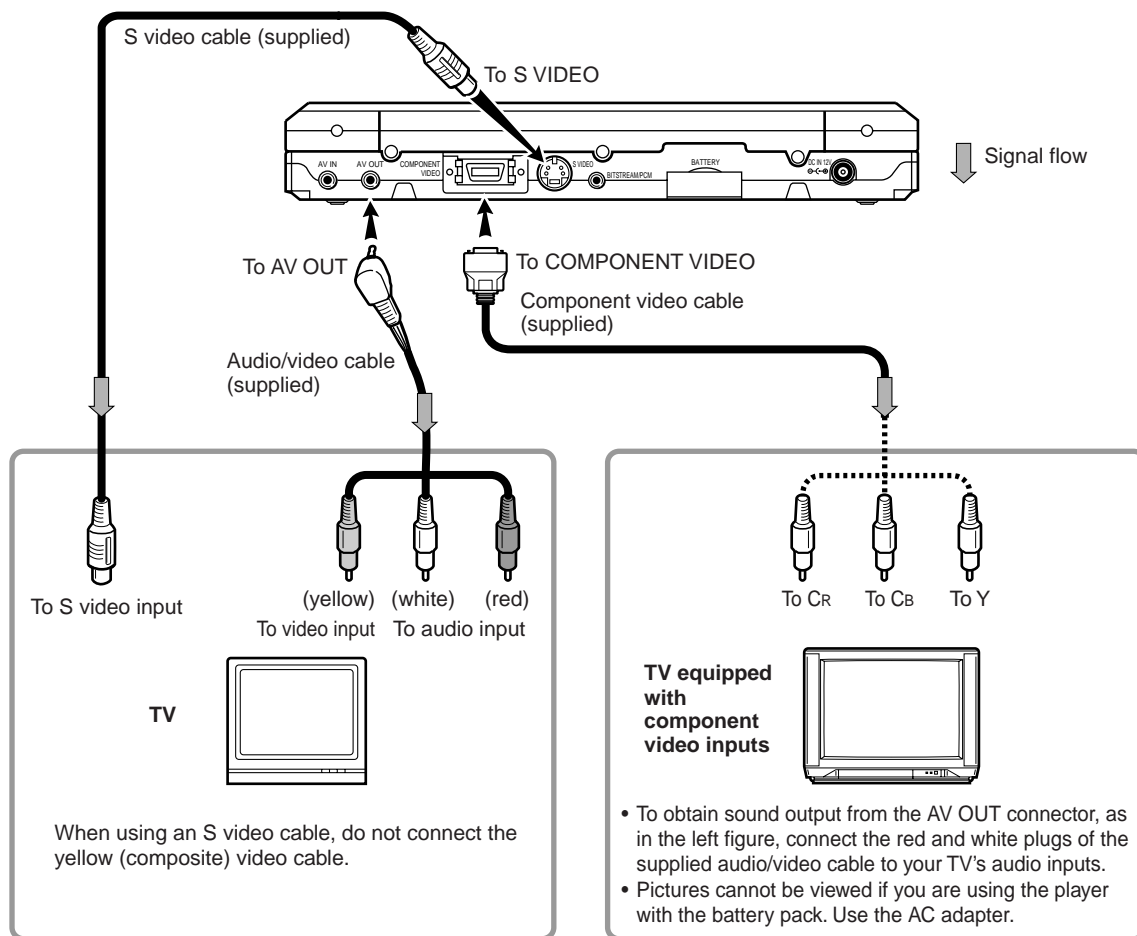

On the setting

- Set the "TV Shape" according to the aspect ratio of your TV. [44](#) [46](#)
- Set the "Audio Out Select" to "Analog 2ch". [44](#) [47](#)
- When you set the "LCD Picture" to "Fine", close the LCD or press the LCD MODE button on the main unit to turn the LCD monitor off. [23](#) [46](#)

INTERLACED outputs/inputs (ColorStream®)

Some TVs or monitors are equipped with component video inputs. Connecting to these inputs allows you to enjoy higher quality picture playback.

Actual labels for component video inputs may vary depending on the TV manufacturer. (ex. Y, R-Y, B-Y or Y, CB, CR)

In some TVs or monitors, the color levels of the playback picture may be reduced slightly or the tint may change. In such a case, adjust the TV or monitor for optimum performance.

Notes

- Refer to the owner's manual of the connected TV (or other equipment) as well.
- When you connect the player to your TV, be sure to turn off the power and unplug both units from the wall outlet before making any connections.
- Connect the player directly to your TV. If you connect the player to a VCR, TV/VCR combination or video selector, the playback picture may be distorted as DVD video discs are copy protected.
- If you place the player near a tuner or radio, the radio broadcast sound might be distorted. In this case, place the player away from the tuner and radio.
- The output sound of the player has a wide dynamic range. Be sure to adjust the receiver's volume to a moderate listening level. Otherwise, the speakers may be damaged by a sudden high volume sound.

Connect to Headphones

You can enjoy sounds by connecting headphones.

Caution

When you use headphones, keep the volume at a moderate level. If you use the headphones continuously with high volume sound, it may cause hearing damage.

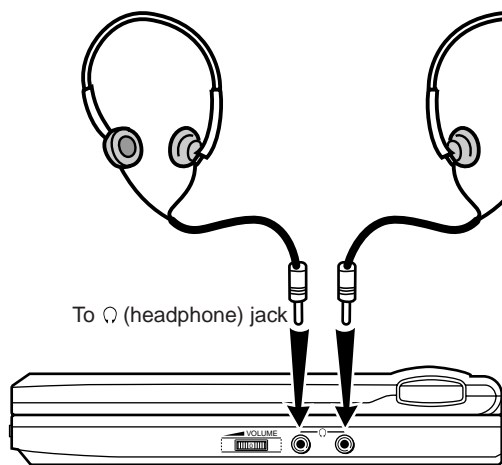

Connecting headphones

Connect headphones to the headphone jack using a stereo mini plug.

Before connecting, temporarily turn down the volume with the headphone volume control. Readjust to your preference when playback starts.

- Turn off the player before you connect or disconnect the headphone cable. Neglecting this may cause abnormal performance of the player.
- You can connect up to 2 headphones.

Viewing Pictures From Connected Video Equipment

You can use the LCD of this player to monitor pictures of video equipment connected via the AV IN jack.

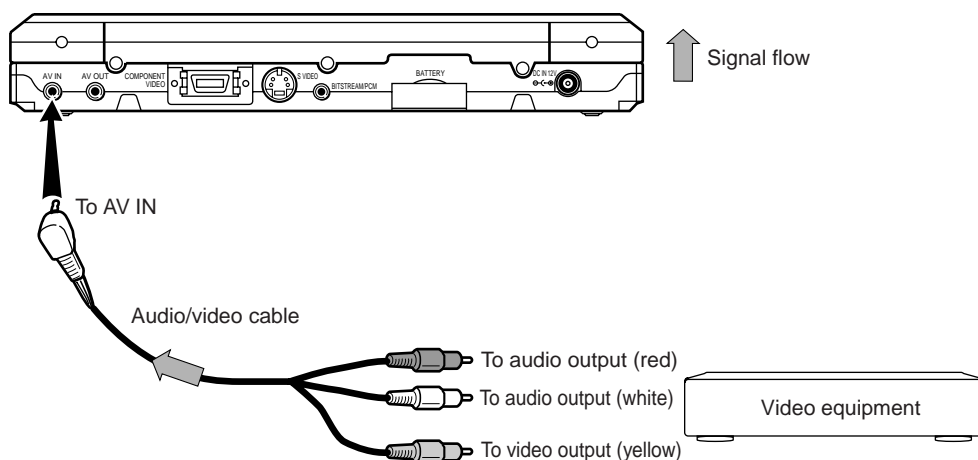





Connecting to Optional Equipment

You can enjoy high quality dynamic sounds by connecting the player to optional audio equipment.

For connection to your TV, see "Connecting to a TV" **56**.

For details of output sound, see **39**.

	: Front speaker		: Center speaker
	: Rear speaker		: Signal flow
	: Sub woofer		

Connecting to an amplifier equipped with a Dolby Digital decoder

Dolby Digital

Dolby Digital is the surround sound technology used in theaters showing the latest movies, and is now available to reproduce this realistic effect in the home. You can enjoy motion picture and live concert DVD video discs with this dynamic realistic sound by connecting the player to a 6 channel amplifier equipped with a Dolby Digital decoder or Dolby Digital processor. If you have a Dolby Pro Logic Surround decoder, you will obtain the full benefit of Pro Logic from the same DVD movies that provide full 5.1-channel Dolby Digital soundtracks, as well as from titles with the Dolby Surround mark.

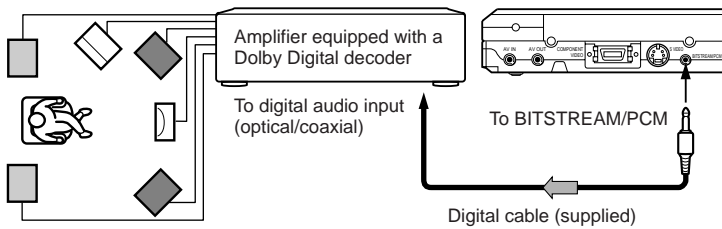

Manufactured under license from Dolby Laboratories. "Dolby", "Pro Logic" and the double-D symbol are trademarks of Dolby Laboratories. Confidential unpublished works. ©1992-1997 Dolby Laboratories. All rights reserved.

- Use DVD video discs encoded via the Dolby Digital recording system.
- Make the following setting.

On-screen display	Select:	Page
"Audio Out Select"	"Bitstream"	44
	"Bitstream"	47
Recording system	 D	39

Connecting to an amplifier equipped with Dolby Pro Logic Surround

Dolby Pro Logic Surround

You can enjoy the dynamic realistic sound of Dolby Pro Logic Surround by connecting an amplifier and speaker system (right and left front speakers, a center speaker, and one or two rear speakers).

- **With an amplifier equipped with Dolby Digital**
Connect the equipment the same way as described in "Connecting to an amplifier equipped with a Dolby Digital decoder." Refer to that amplifier's owner's manual and set the amplifier so you can enjoy Dolby Pro Logic Surround sound.
- **With an amplifier not equipped with Dolby Digital**
Connect the equipment as follows.

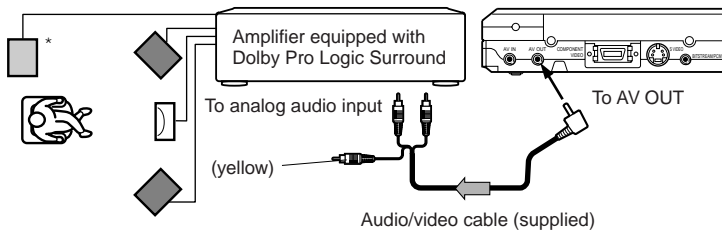

- Make the following setting.

On-screen display	Select:	Page
"Audio Out Select"	"Analog 2ch"	44
	"Analog 2ch"	47

Be sure to set "Audio Out Select" to "Analog 2ch" when you enjoy sounds of Dolby Pro Logic Surround using this connection.

* Connect one or two rear speakers. The output sound from the rear speakers will be monaural even if you connect two rear speakers.

Connecting to an amplifier equipped with a DTS decoder

Digital Theater Systems (DTS)

DTS is a high quality surround technology used in theaters and now available for home use, on DVD video discs or audio CDs.

If you have a DTS decoder or processor, you can obtain the full benefit of 5.1 channel DTS encoded sound tracks on DVD video discs or audio CDs.

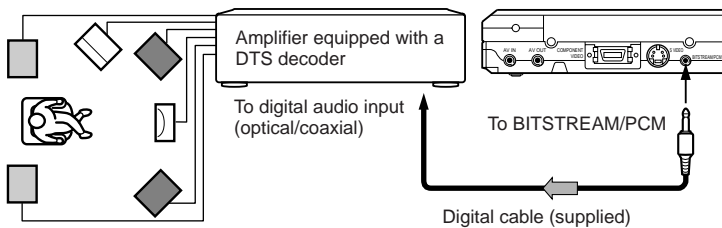

"DTS" and "DTS Digital Surround" are trademarks of Digital Theater Systems, Inc.

- Use DVD video discs or audio CDs encoded via the DTS recording system.
- Make the following setting.

On-screen display	Select:	Page
"Audio Out Select"	"Bitstream"	44
	"Bitstream"	47
Recording system	DTS	39

Warning

- When you are connecting (via the BITSTREAM/PCM jack) an AV decoder that does not have the Dolby Digital, Digital Theater Systems (DTS) or MPEG2 decoding function, be sure to set "Audio Out Select" to "PCM" from the on-screen displays **44** **47**. Otherwise, high volume sound may damage your hearing as well as the speakers.
- When playing DTS-encoded discs (DVD video discs and audio CDs), excessive noise may be output from the analog stereo jacks. To avoid possible damage to the audio system, you should take proper precautions when the AV OUT jack of the player is connected to an amplification system. To enjoy DTS Digital Surround™ playback, an external 5.1 channel DTS Digital Surround™ decoder system must be connected to the BITSTREAM/PCM jack of the player.

Connecting to an amplifier equipped with an MPEG2 audio decoder

MPEG2 sound

You can enjoy motion picture and live concert DVD video discs with dynamic realistic sound by connecting an amplifier equipped with an MPEG2 audio decoder or MPEG2 audio processor.

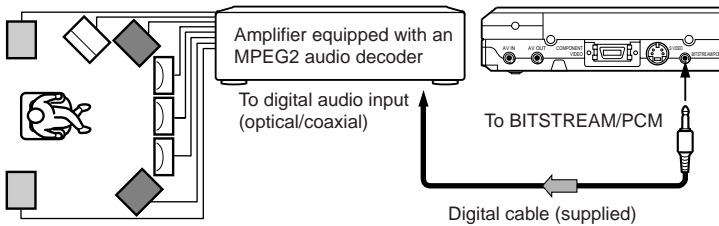

- Use DVD video discs encoded via the MPEG2 recording system.
- Make the following setting.

On-screen display	Select:	Page
"Audio Out Select"	"Bitstream"	44 47
Recording system	MPEG	39

Connecting to an amplifier equipped with a digital audio input

2 channel digital stereo

You can enjoy the dynamic sound of 2 channel digital stereo by connecting an amplifier equipped with a digital audio input and speaker system (right and left front speakers).

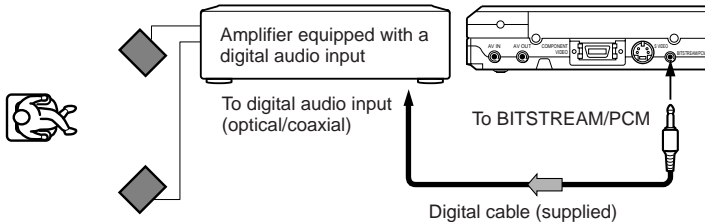

- Make the following setting.

On-screen display	Select:	Page
"Audio Out Select"	"PCM"	44 47

Notes

- DO NOT connect the BITSTREAM/PCM jack of the player to the AC-3 RF input of a Dolby Digital Receiver. This input on your A/V Receiver is reserved for Laserdisc use only and is incompatible with the BITSTREAM/PCM jack of the player.
- Connect the BITSTREAM/PCM jack of the player to the "COAXIAL" input of a Receiver or Processor.
- Refer to the owner's manual of the connected equipment as well.
- When you connect the player to other equipment, be sure to turn off the power and unplug all of the equipment from the wall outlet before making any connections.
- The output sound of the player has a wide dynamic range. Be sure to adjust the receiver's volume to a moderate listening level. Otherwise, the speakers may be damaged by a sudden high volume sound.
- Turn off the amplifier before you connect or disconnect the player's power cord. If you leave the amplifier power on, the speakers may be damaged.

Using the battery pack

Warning

- Do not use a battery pack other than one specified as it can result in a fire or damage to the unit.
- Do not heat, open, or short-circuit the battery pack. Do not throw the battery pack into a fire. Doing so may cause an explosion or a fire.
- Attach the battery pack properly following the explanation below. Make sure that the battery pack is attached firmly to the player when using it. Otherwise, the battery pack may be off its attachment and drop and cause personal injury.

Use a battery pack MEDB02SX (supplied) or MEDB02LX (not supplied). Charge it before using.

■ Attaching the battery pack

First disconnect the AC adapter and the power cord from the player, then attach the battery pack.

- 1 Turn the player off.
- 2 Turn the player upside down.
- 3 Open the connector cover on the rear of the player by pressing it.

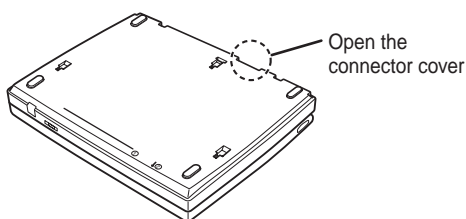

- 4 Place the battery pack turned over by matching it to line ①, insert the hooks of the battery pack into the corresponding holes on the rear of the player.

Then, slide the battery pack in the direction of the arrow ② until a “click” is heard.

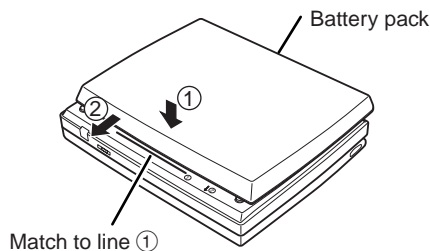

Note

Remove the battery pack from the player after being used.

■ Charging the battery pack

- 1 Attach the battery pack to the player.
- 2 Connect the supplied AC adapter and the power cord to the player. **18**

Charging starts, and the POWER/CHG indicator illuminates in orange.

When the charging is completed, the POWER/CHG indicator turns off.

Notes

- The attached battery pack may get warm when you are charging it or operating the player. This is not a defect.
- The POWER/CHG indicator flashes in green when the power in the battery pack is running out.
- Charge the battery with a surrounding temperature of +10°C to +30°C.

■ Charging time of a battery pack

MEDB02SX (supplied)	approximately 4 hours
MEDB02LX (not supplied)	approximately 5.5 hours

The charging time of a battery pack may vary depending on environment conditions and operational status.

■ LCD brightness while using the battery pack

Since the player operates in a power saving mode when the battery pack is attached, LCD brightness may be reduced. It can be restored by pressing the DIMMER button on the remote control. A brighter LCD display will shorten battery pack life.

■ Time of continuing playback while using the battery pack

MEDB02SX (supplied)	approximately 3 hours
MEDB02LX (not supplied)	approximately 5 hours

(Conditions: 25°C, earphone in use, LCD brightness minimized, new battery pack in use.)

- The time of continuing playback may vary depending on battery pack status, operational status and environment conditions.
- Low temperature will shorten the time of continuing playback.

■ Detaching the battery pack

- 1 Turn the player off.
- 2 Disconnect the AC adapter and the power cord from the player.
- 3 Slide the battery pack's lock switch in the open direction, then slide the player in the direction of the arrow to remove it.

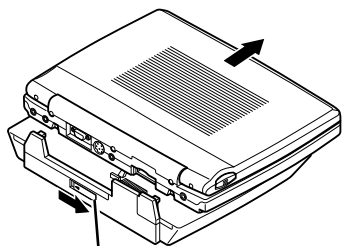

Lock switch

- 3 Close the connector cover on rear of the player.

Note

Do not detach the battery pack while you are operating the player (while the POWER/CHG indicator illuminates in green).

■ About battery pack life

Battery pack has a duration life. When the playback time become short remarkably even if the battery pack is fully charged, change to a new battery pack.

Others

- Before Calling Service Personnel
- Specifications
- LIMITED WARRANTY
PORTABLE DVD PLAYER

Before Calling Service Personnel

Check the following guide for the possible cause of a problem before contacting service.

Symptoms and correction

Symptom	Cause	Correction	Page
No power.	• The AC adapter or power plug is disconnected.	• Connect the AC adapter or power plug securely.	18
	• Dead batteries.	• Re-charge the battery.	—
The player turned off by itself.	• The automatic power off function turned the unit off.	• Press the PLAY button.	23
No picture.	• The connected TV is not set to receive DVD signal output.	• Select the appropriate video input mode on the TV so the picture from the player appears on the TV screen.	20
	• The audio/video cable is not connected securely.	• Connect the audio/video cable securely into the appropriate jacks.	56
	• The "LCD Picture" is set to "Fine".	• Close up the LCD or press the LCD MODE button to turn the LCD monitor off.	46
No sound.	• The equipment connected via the audio/video cable is not set to receive DVD signal output.	• Select the correct input mode of the audio receiver so you can listen to the sound from the player.	40
	• The audio/video cable is not connected securely.	• Connect the audio/video cable securely into the appropriate jacks.	56 58, 59
	• The audio receiver or TV is turned off.	• Turn on the equipment connected with the audio/video cable.	56 58, 59
	• The setting of output sound format is incorrect.	• Select the proper audio setting.	39, 44 47
The playback picture has occasional distortion.	• The disc is dirty.	• Eject the disc and clean it.	13
	• Player is in fast forward or fast reverse mode.	• Sometimes a small amount of picture distortion may appear. This is not a malfunction.	—
	• The main unit was moved or given a shock.	• Vibrating or shaking the unit during playback may produce distortion. This is not a malfunction. If not restored to usual status, stop the playback and start again.	—
	• The disc is not set firmly.	• Remove the disc and set it again.	20
Brightness is unstable or noises are present in the playback pictures.	• The effect of copy protection.	• Connect the player directly to the TV. Avoid connecting the player to a VCR or TV/VCR combination.	56
The player does not start playback.	• No disc is inserted.	• Insert a disc.	20
	• An unplayable disc is inserted.	• Insert a playable disc. (Check the disc type and color system.)	2
	• The disc is inserted upside down.	• Insert the disc with the playback side down.	20
	• The disc is not inserted securely.	• Insert the disc securely in the disc holder.	20
	• The disc is dirty.	• Clean the disc.	13
	• The parental lock function is set.	• Cancel the parental lock function or change the parental lock level.	50
Playback does not follow the course of the disc's program.	• It is in the repeat playback mode, memory playback, etc.	• These operations may prevent a proper progression of the contents.	—
Buttons do not work.	• Power supply fluctuations or other abnormalities such as static electricity may interrupt correct operation.	• Turn the power on or off with the POWER button. Or disconnect the power plug and insert it into the wall outlet again.	—
The remote control does not work properly.	• The remote control is not pointed at the remote sensor of the player.	• Point the remote control at the remote sensor of the player.	17
	• The remote control is too far from the player.	• Operate the remote control within about 7 m.	17
	• The batteries in the remote control are exhausted.	• Replace the batteries with new ones.	17

Player / Connectors / Liquid crystal display / Supplied accessories

Player

Power supply	DC 12 V (Rated current : 2 A) 120 V AC, 60 Hz (with the supplied AC adapter)
Mass	880 g
External dimensions	210 × 31.9 × 160 mm (W/H/D)
Signal system	Standard NTSC
Laser	Semiconductor laser, wavelength 650 nm / 795 nm
Frequency range	DVD linear sound : 48 kHz sampling 4 Hz to 22 kHz 96 kHz sampling 4 Hz to 44 kHz
Operating conditions	Temperature: 5 °C to 35 °C, Operation status: Horizontal

Connectors

Video output (AV OUT)	1.0 V (p-p), 75 Ω, negative sync., Ø3.5mm mini jack × 1
S video output (S VIDEO)	(Y) 1.0 V (p-p), 75 Ω, negative sync., Mini DIN 4-pin × 1 (C) 0.286 V (p-p), 75 Ω
Component video output (COMPONENT VIDEO)	D connector 14-pin, 2 lines, 1.27 mm pitch (Y): 1.0 V (p-p), 75 Ω, (Cb • Cr): 0.7 V (p-p), 75 Ω
Audio output (BITSTREAM/PCM)	Optical/coaxial connector (Ø3.5mm) × 1
Audio output (AV OUT)	1.5 V (rms), 220 Ω, Ø3.5mm mini jack × 1
Video input (AV IN)	1.0 V (p-p), 75 Ω, negative sync., Ø3.5mm mini jack × 1
Audio input (AV IN)	2.0 V (rms), Ø3.5mm mini jack × 1
Headphone terminal	Ø3.5mm stereo mini jack × 2

Liquid crystal display

Panel size	8 inches (99.216 mm × 176.4 mm)
Projection system	TN color transmission
Driving system	TFT active matrix
Resolution	234 × 480 (effective pixel rate : more than 99.99%)

Supplied accessories

Audio/video cable	1
Remote control (MEDR03UX)	1
Coin-shaped battery (CR2025)	1
AC adapter (UA2035)	1
Battery pack (MEDB02SX)	1
Component video cable	1
Power cord	1

• Designs and specifications are subject to change without notice.

LIMITED WARRANTY PORTABLE DVD PLAYER

Toshiba America Consumer Products, Inc. ("TACP") and Toshiba Hawaii, Inc. ("THI") make the following limited warranties. These limited warranties extend to original consumer purchaser or any person receiving this set as a gift from the original consumer purchaser and to no other purchaser or transferee.

Limited Ninety (90) Day Warranty

TACP/THI warrant this product against defects in materials or workmanship for a period of ninety (90) days after the date of original retail purchase. During this period, TACP/THI will repair a defective product or part, without charge to you. You must deliver the entire product to a TACP/THI Authorized Service Station. You are responsible for all transportation and insurance charges for the unit to and from the Authorized Service Station.

Limited One (1) Year Warranty

TACP/THI further warrant the parts in this product against defects in materials or workmanship for a period of one (1) year after the date of original retail purchase. During this period, TACP/THI will repair or replace a defective part, without charge to you, except that if a defective part is replaced after ninety (90) days from the date of the original retail purchase you pay labor charges involved in the replacement. You must also deliver the entire product to a TACP/THI Authorized Service Station. You are responsible for all transportation and insurance charges for the unit to and from the Authorized Service Station.

Rental Units

The warranty for rental units begin with the first rental or thirty (30) days from the date of shipment to the rental firm, whichever comes first.

Commercial Units

Products sold and used for commercial use have a limited ninety (90) day warranty for all parts and labor.

Owner's Manual

You should read the owner's manual thoroughly before operating this product. You should complete and mail the enclosed Demographic card within ten (10) days after you, or the person who has given you this product as a gift, purchased this product. This is one way to enable TACP to provide you with better customer service and improved products. Failure to return the card will not affect your rights under this warranty.

Your Responsibility

The above warranties are subject to the following conditions:

- (1) You must retain your bill of sale or provide other proof of purchase.
- (2) You must notify a TACP/THI/TCL Authorized Service Station within thirty (30) days after you discover a defective product or part.
- (3) All warranty servicing of this product must be made by a TACP/THI/TCL Authorized Service Station.
- (4) U.S.A. warranties are effective only if the product is purchased and operated in the Continental U.S.A. or Puerto Rico.
- (5) Labor service charges for set installation. Set up, adjustment of customer controls and installation or repair of antenna systems are not covered by this warranty. Reception problems caused by inadequate antenna systems are your responsibility.
- (6) Warranties extend only to defects in materials or workmanship as limited above and do not extend to any product or parts which have been lost or discarded by you or to damage to products or parts caused by misuse, accident, damage caused by Acts of God, such as lightning or fluctuations in electric power, improper installation, improper maintenance or use in violation of instructions furnished by us; or to units which have been altered or modified without authorization of TACP/THI/TCL or to damage to products or part thereof which have had the serial number removed, altered, defaced or rendered illegible.
- (7) Physically damaged DVD Units are not acceptable for repair or exchange whether in or out of warranty and will be returned as received.

How to Obtain Service

- (1) Refer to the troubleshooting guide in your owner's manual. This checklist may solve your problem or check our web site at WWW.TOSHIBA.COM/TACP.
- (2) Products shipped to the Service Station must be insured and safely and securely packed, preferably in the original shipping carton, and a letter explaining the defect and also a copy of the bill of sale or other proof of purchase must be enclosed.

In United States contact:

Toshiba America Consumer Products Inc.

(800)-631-3811

In Hawaii contact:

Toshiba Hawaii, Inc.
327 Kamakee St
Honolulu, HI 96814
(808)-521-5377

In Canada contact:

Consumer Electronics Group
191 McNabb St
Markham, Ontario L3R 8H2
(905)-470-5400

Consumer Electronics Group
22171 Fraserwood Way
Richmond, B.C. V6W 1J5
(604)-303-2500

Consumer Electronics Group
1643 North Service Rd
Dorval, QC H9P 1J1
(514)-856-4100

All warranties implied by state law, including the implied warranties of merchantability and fitness for a particular purpose, are expressly limited to the duration of the limited warranties set forth above. With the exception of any warranties implied by state law as hereby limited, the foregoing warranty is exclusive and in lieu of all other warranties, guarantees, agreements and similar obligations of manufacturer or seller with respect to the repair or replacement of any parts. In no event shall TACP/THI be liable for consequential or incidental damages.

No person, agent, distributor, dealer or company is authorized to change, modify or extend the terms of these warranties in any manner whatsoever. The time within which an action must be commenced to enforce any obligation of TACP/THI arising under the warranty or under any statute, or law of the United States or any state thereof, is hereby limited to ninety (90) days from the date you discover or should have discovered the defect. This limitation does not apply to implied warranties arising under state law.

This warranty gives you specific legal rights and you may also have other rights, which may vary from state to state. Some states do not allow limitation on how long an implied warranty lasts, when an action may be brought, or the exclusion or limitation of incidental or consequential damages, so the above provisions may not apply to you.

ATTENTION CANADIAN CONSUMERS: (Toshiba Canada "TCL")

Canadian consumers are requested to complete the special Canadian "Warranty Registration Form" enclosed, and forward this completed form with a copy of bill of sale to TOSHIBA OF CANADA to "Register and Validate" their warranty. Product must be purchased from an Authorized Canadian Dealer.

IMPORTANT: PACKING AND SHIPPING INSTRUCTION

When you send the product to a Service Station, you must use the original carton box and packing material, then insert the original carton box containing the unit into another carton, using more packing material.

Products purchased in the U.S.A. and used in Canada are not covered by these warranties.

Products purchased in Canada and used in the U.S.A. are not covered by these warranties.

TOSHIBA

Printed in Japan